

Committed  
to Quality

# ISE, Inc. DaqPRO™

All in one solution for data logging and  
analysis



including

**DaqLab™**

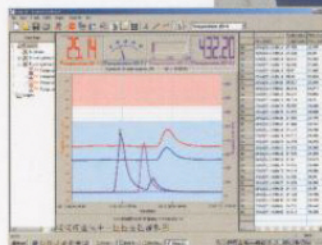

## User Guide

<http://DaqPRO.com>

  
fourier

# DaqPRO

## *User Guide*

Fourier Systems

Fourth Edition

First print

Printed in March 2005



fourier

# Contents

Introduction .....	7
Chapter 1    DaqPRO.....	9
1.1.    General.....	9
1.1.1.    DaqPRO: system contents.....	9
1.1.2.    External connections.....	10
1.1.3.    Sensor types and connections .....	11
1.1.4.    User defined sensors .....	13
1.1.5.    Alarms.....	13
1.1.6.    Alarm output.....	14
1.1.7.    Sensor calibration .....	15
1.1.8.    Serial number and comment .....	15
1.1.9.    Battery.....	15
1.1.10.    Mains Adaptor.....	15
1.2.    Stand-Alone Operation.....	16
1.2.1.    Front Panel Layout.....	16
1.2.2.    Quick-Start.....	17
1.2.3.    Working with the DaqPRO Menus.....	21
1. Main menu display.....	21
2. Menu buttons.....	22
3. Menu Icons and commands.....	22
1.2.4.    Graphic Display.....	24
2. The Cursor.....	25
3. Zooming.....	25
1.2.5.    Load the Last Setup .....	25
1.2.6.    Configure Your DaqPRO.....	26
1. Input Filter.....	26
2. Averaging points.....	27
3. Temperature units .....	27
4. Clear memory .....	27
5. Screen contrast .....	27
1.2.7.    Internal Clock and Calendar.....	27
1.2.8.    Clear the Memory.....	27
1.2.9.    Choose the Right Setup .....	28
1.2.10.    Programming Rules and Limitations .....	30

Chapter 2	Working with DaqLab .....	31
2.1.	Install the Software .....	31
2.1.1.	System Requirements .....	31
2.1.2.	Installation .....	31
2.2.	Overview .....	33
2.2.1.	DaqLab On-screen Layout .....	33
2.2.2.	Working with Projects .....	33
2.2.3.	DaqLab Window Layout .....	34
2.3.	Getting Started .....	35
2.3.1.	Set up a Recording Session .....	35
	1. Prepare DaqPRO .....	35
	2. Setup the DaqPRO .....	35
	3. Start Recording .....	35
2.3.2.	Data recording options .....	36
	1. Single measurement .....	36
	2. Replace .....	36
	3. Add .....	36
2.3.3.	Download Data .....	36
2.3.4.	Save Data .....	37
2.3.5.	Open a File .....	37
2.3.6.	Create a New Project .....	38
2.3.7.	Import data .....	38
2.3.8.	Date format settings .....	39
2.3.9.	Print .....	40
	1. Print a graph .....	40
	2. Print a table .....	41
2.4.	View the Data .....	42
2.4.1.	Display Options .....	42
2.4.2.	Graph Display .....	42
	1. Split graph view .....	42
	2. The Cursor .....	43
	3. Zooming .....	43
	4. Panning .....	45
	5. Edit the Graph .....	45
	6. Display alarm levels .....	46
	7. Format the graph .....	46
	8. Change the graph's units and its number format .....	47
	9. Add a graph to the project .....	47

2.4.3.	The Table Display .....	48
	Formatting the table.....	49
2.4.4.	Meters .....	49
2.4.5.	Data Map .....	50
	1. Control the display with the Data Map .....	50
	2. Understanding Data Map icons .....	51
2.4.6.	Export Data to Excel .....	52
	Export file settings .....	52
2.4.7.	Copy the Graph as a Picture .....	52
2.5.	Program DaqPRO .....	53
2.5.1.	Setup.....	53
	1. Quick setup.....	53
	2. Alarm setup .....	55
	3. Low pass filter.....	56
	4. Averaging .....	57
	5. Battery level.....	57
	6. Presetting the display .....	57
	7. Preset the graph's X-axis.....	58
	8. Triggering .....	58
2.5.2.	Start Recording .....	60
2.5.3.	Stop Recording .....	60
2.5.4.	Clear DaqPRO's Memory.....	60
2.5.5.	Adding comment to DaqPRO .....	60
2.5.6.	Edit DaqPRO's Notes.....	61
2.5.7.	Temperature units .....	61
2.5.8.	Calibrating the Sensors.....	62
	1. Calibration options.....	62
	2. Calibration password .....	63
	3. Calibration procedure .....	63
2.5.9.	Define a Custom Sensor .....	69
	1. To define a new sensor: .....	69
	2. To use the custom sensor: .....	70
	3. Working with 4-20mA transducers.....	70
2.5.10.	Communication Setup.....	71
2.6.	Analyze the data.....	73
2.6.1.	Reading Data Point Coordinates.....	73
2.6.2.	Reading the Difference Between two Coordinate Values.....	73
2.6.3.	Working with the Analysis Tools.....	73
2.6.4.	Smoothing.....	73

2.6.5.	Statistics.....	74
2.6.6.	Most Common Analysis Functions .....	74
	1. Linear fit.....	74
	2. Derivative.....	75
	3. Integral .....	75
2.6.7.	The Analysis Wizard .....	75
	1. Using the Analysis Wizard.....	75
	2. Curve fit .....	76
	3. Averaging .....	77
	4. Functions.....	78
2.6.8.	Available Analysis Tools.....	79
	1. Curve fit .....	79
	2. Averaging .....	79
	3. Functions .....	80
2.7.	Special Tools.....	84
2.7.1.	Crop Tool .....	84
	1. To trim all data up to a point .....	84
	2. To trim all data outside a selected range .....	84
2.8.	Toolbar Buttons .....	85
2.8.1.	Main (upper) Toolbar.....	85
2.8.2.	Graph Toolbar.....	86
Chapter 3	Troubleshooting Guide.....	88
Chapter 4	Specifications.....	90
	Ordering Information .....	92
	Appendix: Figures .....	93
	Appendix: Simplified measurement circuits.....	94
	Index .....	96

# Introduction

DaqPRO is an eight-channel portable data acquisition and logging system with graphic display and built-in analysis functions

DaqPRO is battery operated and is capable of sampling, processing and displaying measurements without connecting to a computer. Designed to serve the needs of professional data loggers, DaqPRO is a professional, cost-effective, compact and stand-alone data logging system that can be used with a wide variety of applications. This 16-bit, high-resolution, eight-channel data logger offers the professional graphic displays and analysis functions for measuring voltage, current and temperature in real-time.

With its high resolution and fast Analog to Digital converter (ADC), DaqPRO meets the majority of data logging requirements in most industrial applications. Its unique ability to display measured values and analyze them in real-time on a graphical interface minimizes the need to download collected data to a computer for further analysis.

Every DaqPRO unit is embedded with a unique serial number and can be loaded with a descriptive comment for safe identification.

DaqPRO 5300 includes eight input channels for measuring voltage, current, temperature and pulses. Selectable ranges for each input are 0-24mA, 0-50mV, 0-10V, a large variety of NTC, PT-100 and thermocouple temperature sensors including internal temperature, pulse counter, frequency meter and up to 20 user defined sensors. The inputs use pluggable screw terminal blocks for easy connection.

An internal clock and calendar keep tracks of the time and date of every sample measured.

DaqPRO can automatically activate external alarm events when data is outside a specified range.

DaqPRO is very easy to use because all its functions are broken down into an 8-icon menu, its four buttons can browse every menu and execute any of the commands.

A rechargeable battery powers the data logger, which shuts off automatically after 15 minutes have passed since the time of the last data recording, the time the last button was pressed, or the time the last communication was made with the PC.

The DaqPRO system also comes with the powerful DaqLab software. When the DaqPRO is connected to a PC, live displays can be viewed at rates of up to 100/s, and automatic downloads can be carried out at higher rates. The WINDOWS™ based software can display the data in graphs, tables or meters, can analyze data with various mathematical tools, or export data to a spreadsheet.

DaqLab also enables you to setup DaqPRO and to send advanced commands such as alarm settings, triggering conditions and text notes.

This manual is divided into three sections:

- The first section is dedicated to the data logger itself. Topics include: Connecting sensors, configuration through the data logger keypad, and using the LCD-graphic display to take measurements when working offline.
- The second section gives a comprehensive overview of the DaqLab software. Topics include: How to download data from the data logger to a PC, analyzing the data both graphically and mathematically and using the DaqLab software to program the data logger when working online.
- The third and last section contains hardware specifications and a comprehensive troubleshooting guide that gives answers to common questions.



# Chapter 1

## DaqPRO

This section will focus on the DaqPRO's data collection device – the data logger; and includes:

- How to operate the DaqPRO's keypad,
- How to set up DaqPRO
- How to connect sensors to DaqPRO
- How to connect DaqPRO to your PC.
- How to conduct a logging session

### 1.1. General

#### 1.1.1. *DaqPRO: system contents*

1. The DaqPRO Data Logger
2. USB communication cable
3. An AC-DC adaptor
4. DaqLab software installation CD
5. User Guide
6. Carrying case

### 1.1.2. External connections

1. Sensor Inputs/alarm output

8<sup>th</sup> input/output      1<sup>st</sup> input

2. PC USB connection socket

3. Power input (DC 9 – 12V)

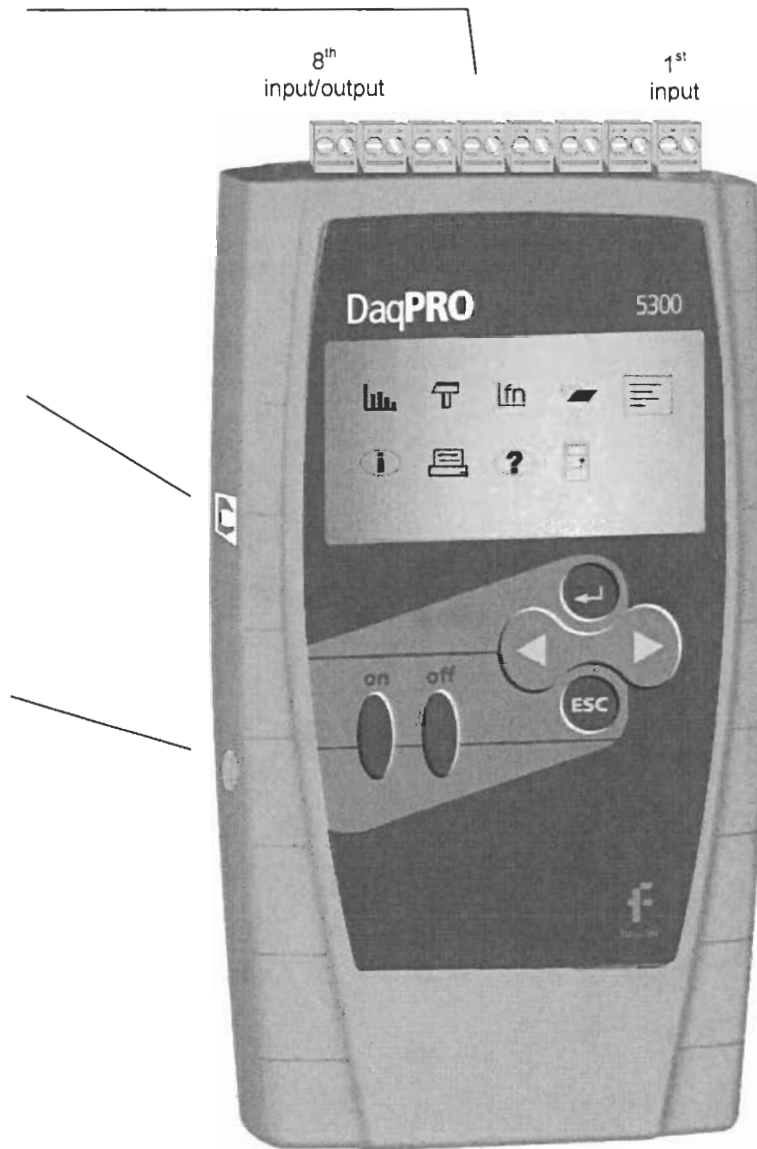

Figure 1: DaqPRO external connections

1. **Sensor inputs/alarm output** – pluggable screw terminal block (marked Input -1 to Input – 8 from right to left). All eight inputs can be used simultaneously.

If you are using one sensor, connect it to input 1. If you are using two sensors connect them to inputs 1 and 2, and so on...

I/O-8 (Input/Output-8) serves either as an input or as alarm output.

To connect a sensor to the DaqPRO unplug the screw terminal, connect the sensor's wires to the terminals, and then plug the terminal back to the corresponding socket on the input block.

2. **Computer USB communication socket** – use this socket to connect DaqPRO to a computer  
Connect the USB Type B plug (square plug) of the supplied communication cable to the DaqPRO and the USB Type A plug (flat plug) to the computer (see page 32 for USB driver installation).
3. **External DC power supply socket** – Plug in an AC/DC 9 - 12V adaptor whenever you want to save battery power, or to charge the battery when necessary. Connecting external power to the DaqPRO automatically charges the internal battery. The adaptor should meet the required specifications (see section 1.1.10 on page 15).

### 1.1.3. *Sensor types and connections*

Each of the 8 input channels of DaqPRO is multipurpose and can be individually configured to any of the following types and ranges:

Sensor	Type	Range
Current		0 – 24mA
Frequency (input 1 only)		20 to 4000Hz
Pulse counter (input 1 only)		0 to 65,000 pulses
Temperature	Internal	-25 to 70°C
Temperature	NTC 10K	-25 to 150°C
Temperature	NTC 100K	-25 to 150°C
Temperature	PT-100 2 wire	-200 to 400°C
Temperature	PT-100 3 wire	-200 to 400°C
Temperature	Thermocouple J	-200 to 1200°C
Temperature	Thermocouple K	-250 to 1200°C
Temperature	Thermocouple T	-200 to 400°C
Voltage		0 – 10V
Voltage		0 - 50mV
User defined	Up to 20 types	0 – 10V or 0 – 24mA

Connect the sensor to the terminal block at the top of DaqPRO:

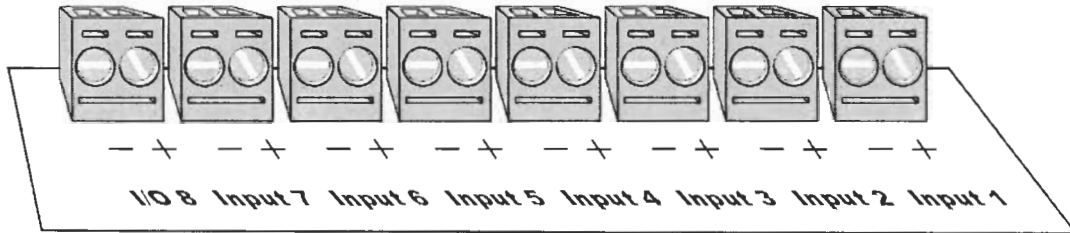

Figure 2: DaqPRO's inputs block terminal

Sensors must be added successively, starting with input-1. If a single sensor is used it must be connected to Input-1. If two sensors are used, they must be connected to Input-1 and Input-2 and so on...

### Alarm output

I/O-8 (Input/Output-8) serves either as an input or as alarm output.

### Polarity

Current, voltage, thermocouples and user defined sensors have distinct polarity. Be careful to connect them in the right polarity.

### Frequency/Pulse counter

Connect the signal wires to I/O-8 screw terminals, and select **Frequency** or **Pulse counter** for **input 1** from the Setup menu. Inputs 2 to 7 are still available for other sensors.

The Frequency/pulse counter is optically isolated from the internal circuitry and can simultaneously measure a signal source, together with another input.

### 3 wire PT 100

You have to use two inputs to connect a 3 wire PT 100 You can connect one 3 wire PT 100 to input-1 and input-5, and/or inputs 2 and 6, and/or inputs 3 and 7 and/or inputs 4 and 8.

Connect the single wire to the plus (+) terminal of the first input and the common end wires to the minus (-) terminals of both the inputs. See Figure 3 for wiring configuration of a 3 wire PT 100 connected to input-1 and input-5:

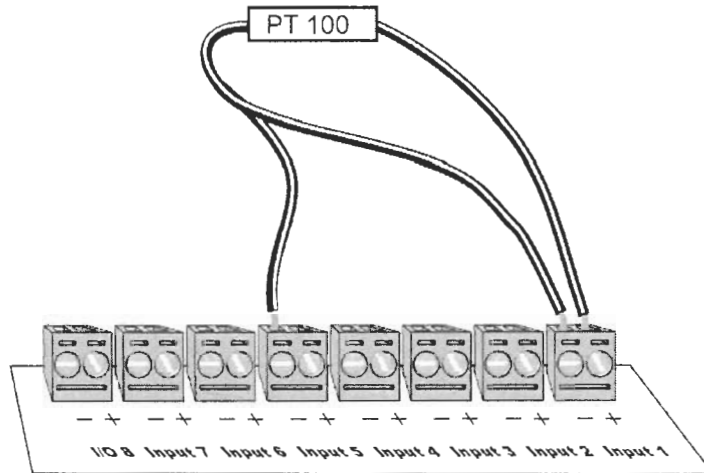

Figure 3: connecting 3 wire PT 100

When working with a 3 wire PT 100 inputs 5 to 8 are not available and you can connect up to 4 sensors.

#### **Sensor mismatch**

After logging begins DaqPRO checks if the sensor type assigned to each channel matches the attached sensor. If there is a mismatch, DaqPRO disconnects the corresponding input and displays a warning message: “Illegal sensor” (see ‘Troubleshooting Guide’ on page 87 for details)

#### *1.1.4. User defined sensors*

DaqPRO provides a simple and straightforward tool for defining up to 20 custom sensors. Almost any 0 – 10V and 0 – 24mA sensor or transducer is accepted by MultiLogPRO and its electrical units are automatically scaled to meaningful user-defined engineering units.

The sensor definitions are stored in DaqPRO’s memory and are added to the sensors list. The sensor’s readings are displayed in the user defined units both on DaqPRO’s LCD screen and DaqLab software.

To learn how to define custom sensors see section 2.5.9 on page 68

For further manipulating sensors readings use the Analysis wizard (see page 74)

#### *1.1.5. Alarms*

Users can define minimum and maximum alarm levels for each input individually.

DaqPRO places a small alarm icon  next to the corresponding input readings and can switch alarm output if either level is breached.

To display alarm warnings in real-time DaqPRO must be in numeric display mode (see page 20).  
To learn how to enter alarm levels and to activate alarm output, see section 2.5.1.2 on page 54.

### 1.1.6. Alarm output

DaqPRO can trigger an external event (e.g. sound alarm, warning light or oven).

Connect the external current loop to the screw terminals of I/O-8. Be careful to connect the external power supply in the right polarity (see Figure 4 below).

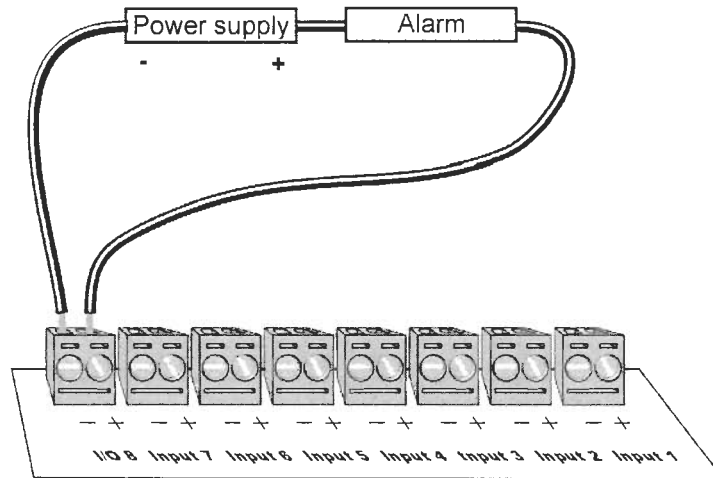

Figure 4: connecting external alarm device

The alarm output is analogous to electrical switch. In OFF position the terminals of I/O-8 are disconnected. In ON position they are shortened.

If an alarm output is selected this input/output is set to OFF position. When any active alarm level is exceeded the output is set to ON. All active alarms must be false to reset the output to OFF position.

The maximum switch load is 50mA, 5V. The output is protected by 50mA reset-able fuse. For higher loads use a relay.

To learn how to enter alarm levels and to activate alarm output, see section 2.5.1.2 on page 54

### 1.1.7. *Sensor calibration*

DaqPRO ships fully calibrated. However, further calibration can be applied via DaqLab. The calibration parameters are sent to DaqPRO and stored in its memory. See page 61 for calibration instructions.

### 1.1.8. *Serial number and comment*

Every DaqPRO unit is embedded with a unique serial number and can be loaded with a descriptive comment to identify its task and location.

To add or edit the comment connect DaqPRO to the computer and use DaqLab software (see page 59).

Every time data is transferred to the computer it is labeled both with DaqPRO's serial number and comment and then displayed in the graph title.

The serial number is marked on the back of the product. To view its comment, select System information from DaqPRO's main menu.

### 1.1.9. *Battery*

DaqPRO is equipped with a 7.2V Ni-MH rechargeable battery. Before you first start working with DaqPRO, charge the unit for 10 to 12 hours while it is turned off. Battery life is approximately 40 hours between charges.

If the data logger's main battery runs out, the internal 3V Lithium battery backs up the memory, so no data will be lost. The Lithium battery also keeps the internal clock and calendar running.

**Note:** Before storing the data logger make sure you have unplugged all the sensors and pressed the OFF key.

### 1.1.10. *Mains Adaptor*

The Mains adaptor (AC/DC adaptor) converts mains power (from a wall outlet) to a voltage suitable to DaqPRO.

- Output: Capacitor filtered 9 to 12 VDC, 400mA.
- Female plug, center Negative.

## 1.2. Stand-Alone Operation

One way to program the DaqPRO is to use its keypad and screen (The other way is to use the DaqLab software – see page 52). The keypad allows us to set all the parameters for data collection, while the LCD screen displays the setting values.

### 1.2.1. Front Panel Layout

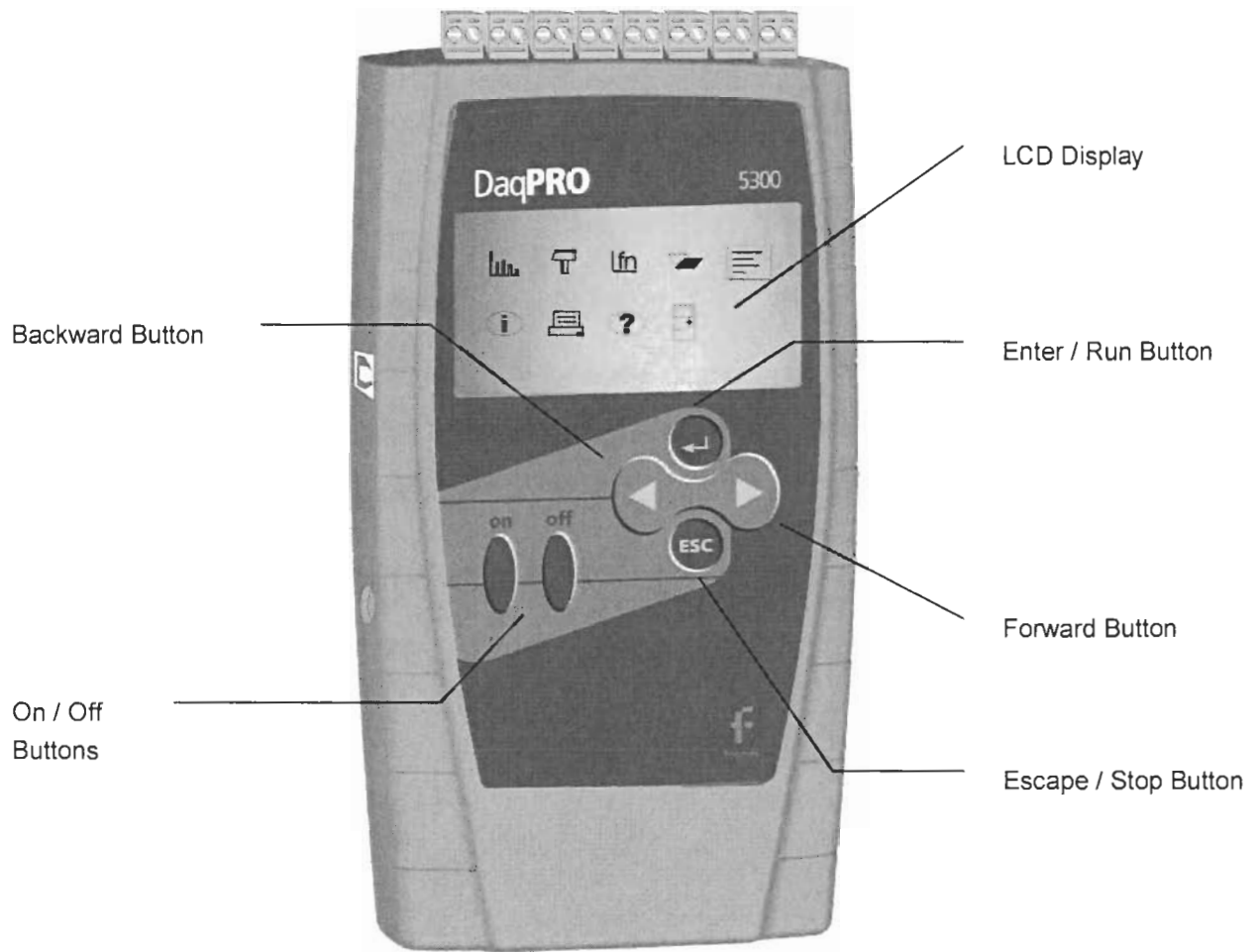

Figure 5: DaqPRO front panel



### 1.2.2. Quick-Start

Before you first use DaqPRO, charge the unit for 10 to 12 hours while it is turned off.

#### 1. Turn on DaqPRO

Press the **on** button. You will see the initialization screen. DaqPRO performs a brief self-check and display its status including battery level and operating mode. At this point you can load the last setup you used (see page 25). If you need a new setup wait until you see the Main Menu screen:

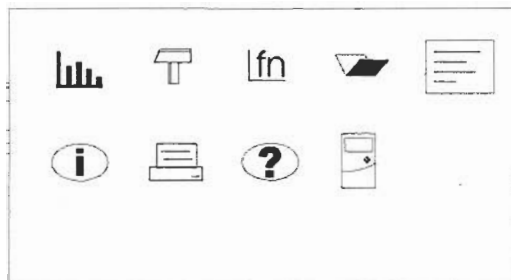

#### 2. Connect the sensors

Start with the first input on the right.

**Note:** Sensors must be added successively, starting with input 1. If a single sensor is used it must be connected to Input 1. If two sensors are used, they must be connected to Input 1 and Input 2.

See Sensors types and connections on page 11 for more details

#### 3. Identify the Sensors

You must tell DaqPRO what type of sensor is connected to each input

1. In the Main Menu screen, use the **Forward**  **arrow** buttons to



select the **setup** menu icon



2. Press the **Enter** button  to enter the setup menu:

```
→ Input - 1 Voltage 0-10V
   Input - 2 Empty
   Input - 3 Empty
   Input - 4 Empty

   RATE = Every sec
   SAMPLES = 500
   DISPLAY = numeric
```

3. Use the **Forward**  and **Backward**  **arrow** buttons to

select the sensor in input 1 and then press the **Enter** button.   
The arrow indicator will move to the second input.

4. Repeat this procedure with all the sensors you plugged in.  
5. After the fourth sensor has been selected, the screen will list the next 4 sensors:

```
→ Input - 5 Empty
   Input - 6 Empty
   Input - 7 Empty
   Input - 8 Empty

   RATE = Every sec
   SAMPLES = 500
   DISPLAY = numeric
```



You can press the **Enter** button in the last input if you want to go back to the first input.

6. When you've finished selecting the sensors press the **Escape** button.



The arrow indicator will point to the **Rate** command.

#### 4. Select Rate

Use the **Forward**  and **Backward**  arrow buttons to select the desired rate, then press the **Enter** button .

```
Input - 1      Curent 0-24mA
Input - 2      NTC 10K
Input - 3
Input - 4

      RATE      = Every 10 sec
→     SAMPLES   = 500
      DISPLAY= numeric
```



DaqPRO automatically switches to the next step in the setup process and the arrow moves to the "samples" row.

#### 5. Select total number of samples

Use the **Forward**  and **Backward**  arrow buttons to select the number of samples, then press the **Enter** button .

Input - 1	Microphone
Input - 2	Light
Input - 3	
Input - 4	
RATE	= Every sec
SAMPLES	= 10,000
→ DISPLAY	= numeric

### 6. Choose display

Use the **Forward**  and **Backward**  arrow buttons to select the type of display, then press the **Enter** button .

Input - 1	Microphone
Input - 2	Light
Input - 3	
Input - 4	
SAMPLES	= 500
DISPLAY	= graphic
→ START	= ( > ).

**Note:** When you turn the DaqPRO off it will save the setup for the next session.

### 7. Start recording

Press the **Forward** arrow button  to start recording.

Or press the **Enter** button if you want to go back to the first item (Rate).

You can stop recording at any time by pressing the **Escape** button



### 1.2.3. Working with the DaqPRO Menus

#### Turning DaqPRO on and off

**On** Turn DaqPRO on

**Off** Turn DaqPRO off

**Note:** Pressing OFF **will not** erase the sample memory. The data stored in the memory will be kept for up to 5 years.

#### 1.Main menu display

When turned on, DaqPRO opens with a system information window and then displays the main menu:

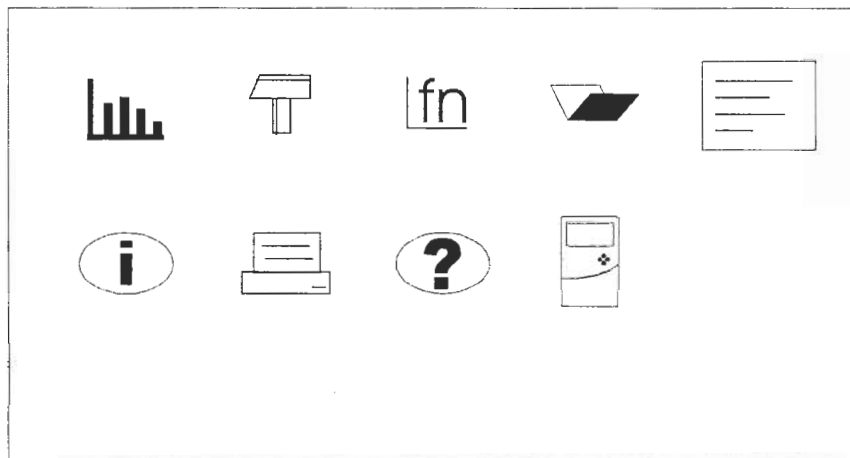

DaqPRO has 9 menus. Use the Forward or Backward **Arrow** buttons to highlight a menu and press the **Enter** button to select it. Then use the **Arrow** buttons to scan the options. Press the **Enter** button to select an option. The DaqPRO automatically executes the command.

## 2.Menu buttons



**Forward**

Move to the next menu or to the next menu options



**Backward**

Move to the previous menu or menu options



**Enter (Start)**

Enter the selected menu or select the current menu option and move to the next menu command or start recording



**Escape (Stop)**

Return to the main menu or stop recording

## 3.Menu Icons and commands



**Start**

Start recording

Press the **Enter** button to start recording



**Setup**

Setup DaqPRO in 4 steps:

**Rate** – select recording rate

**Samples** – select the total number of recording points

**Display** – select the way DaqPRO will display the data (at a rate of up to 1 sample per second):

- 1) Numeric – displays the sensor values and the sample number.
- 2) Meter – displays all active sensors in a bar meter display along with their values (without decimals).
- 3) Table – displays the last 6 values of all the active sensors in a table (without decimals)
- 4) Graphic – displays a graphic representation of the sampled sensors.

At rates higher than 1/s the DaqPRO will display the data in a graph at the end of the logging period.

**Start** – press the Forward **arrow** to start recording



**Function** Display statistics of the current data

- 1) Minimum – the minimum graph value.
- 2) Maximum – the maximum graph value.
- 3) Average – the graph average.

Use the **Enter** button to browse the different sensors



**Open** Open a stored data in graphic display

Use the Forward and Backward **Arrow** buttons to browse the stored files, press the **Enter** button to open a file



**Notes** Display user information

Use the **Arrow** buttons to browse the notes.  
You can use the DaqLab software to edit the notes or to write new notes



### **System information**

Display system information:

- 1) Comment (use DaqLab to enter a comment)
- 2) Number of files stored in DaqPRO's internal memory
- 3) Memory usage
- 4) Battery level (unplug any sensor and external power supply)
- 5) Ambient temperature (the readings of the internal temperature sensor)
- 6) Current date and time



### **Help**

On-line help and specifications



### **Configuration**

Configure the DaqPRO:

**Filter** – turn input filter on and off

**Average** – select number of averaging points

**Temperature units** – select between Fahrenheit and Celsius

**Clear memory**– delete the stored data files

**Contrast** – use the **arrow** buttons to tune the screen contrast

#### **1.2.4. Graphic Display**

DaqPRO will automatically use a graphic display in three cases:



1. If the recording rate is every second or less and you selected Graphic Display in the setup menu
2. Once logging has ended for a recording rate of over one per second.
3. When opening a stored recording.

The graphic display is available for recordings with up to 4 sensors simultaneously.





## 2. The Cursor

Use the Cursor in Graphic Display mode to read data values or to zoom in to the area around a selected point. The cursor is displayed automatically after logging has ended, or when opening a stored recording.

1. Use the **Forward**  and **Backward**  **arrow** buttons to move the cursor.
2. DaqPRO displays the point coordinates at the bottom of the graph.
3. If there is more than one sensor, press the **Enter** button  to move the cursor to another plot on the graph.

## 3. Zooming

1. Position the cursor in the area you want to zoom into.
2. Press the two arrow **buttons**,  **and** , simultaneously. You will zoom in around the cursor in a 2:1 ratio.
3. Press the **Escape** button  to zoom out.

### 1.2.5. Load the Last Setup

When you turn DaqPRO on, once the self testing has been completed, it will display:

```

_ _ _ INITIALIZATION _ _ _
DaqPRO Ver 1.0
Init. Display
Init. RAM
Batt. 99%

ENTER - load setup
```

Press the **Enter** button  to load the last setup.

### 1.2.6. Configure Your DaqPRO

Use the **System configuration** menu to turn input filter on and off, to select number of averaging points, to set temperature units, to clear the DaqPRO's memory or to change the screen contrast.

In the **MAIN MENU** screen, select the **System configuration** icon  to display the configuration screen:

```
--- CONFIGURATION ---  
-> Input filter Off  
    Average 4 samples  
    Temperature in °C  
    Clear memory ( > )  
    Contrast ( < ) ( > )
```

Use the **Forward**  and **Backward**  arrow buttons to select the mode and then press the **Enter** button  to move to the next item. You can press the Escape button  to leave the configuration menu at any time, saving the new changes you made. Press **Enter** button in the last item (Contrast) if you want to go back to the first item (Input Filter).

The new configuration will be saved until the next time you change it.

#### 1. Input Filter

To filter out 50/60Hz line noises use the low pass RC input filter.

Use the **Forward**  and **Backward**  arrow buttons to turn input filter on and off  
When turned on, the low pass filter is applied to all inputs except for 24mA current measurements

## 2.Averaging points

Use this option to reduce random noises. DaqPRO replaces every data sample with the average of the last preset number of samples.

Use the **Forward**  and **Backward**  **arrow** buttons to select the number averaging samples.

## 3.Temperature units

Use the Arrow buttons to select between Fahrenheit (°F) and Celsius (°C) temperature units.

## 4.Clear memory

Press the **Forward** arrow button  if you want to delete all previous data files from the DaqPRO.

## 5.Screen contrast

Use the **arrow** buttons to adjust the LCD screen contrast.  
Any contrast adjustment will be saved until the next time you change it.

### 1.2.7. *Internal Clock and Calendar*

The internal clock is set the first time you use the **Setup** command from the DaqLab software to program the DaqPRO, and is automatically updated to the PC's time and date each time you connect your DaqPRO to a PC.

The internal clock and calendar is kept updated independent of the 7.2V battery condition, even when the DaqPRO is turned off.

### 1.2.8. *Clear the Memory*

If you want to start recording and the DaqPRO's internal memory is full you will see this message at the bottom of the display:

Input – 1	Voltage 0–10V
Input – 2	Empty
Input – 3	Empty
Input – 4	Empty
SAMPLES = 200	
DISPLAY= graphic	
Mem full, clear = ( > )	



Press the **Forward** arrow button to clear the memory

In order to clear the DaqPRO's memory when it is not full, use the **Memory clear** command from the **Configuration** menu (see page 26), or clear the memory from the **Logger** menu in the **DaqLab software** (see page 59).

### 1.2.9. *Choose the Right Setup.*

1. **Sampling rate** - The sampling rate should be determined by the rate of change of the phenomenon being sampled. If the phenomenon is periodic, sample at a rate of at least twice the expected frequency. Changes in temperature can be measured at slower rates such as once per second or even slower, depending on the speed of the expected changes. Usually it's a good practice to sample at a rate 10 times higher than the expected frequency but for extremely smooth graphs, the sampling rate should be about 20 times the expected frequency.

**Note:** Sampling at a rate slower than the expected rate can cause "frequency aliasing". In such a case, the graph will show a frequency much lower than expected. In Figure 6 below, the higher frequency sine wave was sampled at 1/3 of its frequency. Connecting the sampled points yielded a graph with a lower, incorrect frequency.

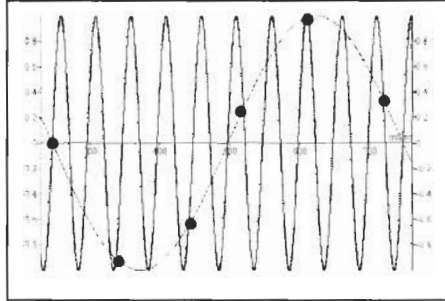



Figure 6: Frequency Aliasing

**Manual** sampling - use this mode for:

- Recordings or measurements that are not related to time.
- Situations in which you have to stop recording data after each sample obtained, in order to change your location, or any other logging parameter (Note: During recording NO CHANGES can be made to the DaqPRO's configuration).

To start a recording using manual data logging, set the **RATE** to "manual" and press the **Enter**

button  once to start the data recording, then press the **Enter** button each time you want to collect a sample.

2. **Sampling Points** - After you have chosen the sampling rate, choosing the number of points will determine the logging period:  $\text{Samples} / \text{Rate} = \text{Logging time}$ . You can also choose the duration of a run first, and then calculate the number of samples:  $\text{Samples} = \text{Logging time} \times \text{Rate}$ .

### Continuous

In the Continuous mode, DaqPRO must be connected to the PC and the DaqLab software must be running. In this mode DaqPRO can continue logging indefinitely. The data is automatically downloaded to the computer, displayed in a real time graph and saved every 10 minutes.

DaqPRO stores the data until its memory is full. You can download this data only if you stopped logging before this point.

To operate in Continuous mode select **RATE** equal to or less than 1/s and **SAMPLES = Continuous**.

You can also select Continuous mode directly from the DaqLab software.

**Note:** DaqPRO must be set to a display mode other than graphic to enable the Continuous mode.

### 1.2.10. Programming Rules and Limitations

The following are some rules and limitations you must take into account when programming the DaqPRO. As DaqLab integrates all programming limitations automatically, setting up DaqPRO via DaqLab will only allow the programming of settings that comply with the rules below.

#### 1.Sampling rate:

The number of sensors in use limits the maximum sampling rate:

1. Maximum sampling rate with one sensor is 4000/s
2. Maximum Temperature sampling rate is 1/s
3. Maximum sampling rate with two sensors or more is 1/s
4. Maximum sampling rate with two PT 100 sensors or more is every 10 seconds
5. Maximum sampling rate with five sensors or more and at least one is NTC or TC (J,K or T) is every 10 seconds
6. Maximum sampling rate with seven sensors or more is every 10 seconds
7. Maximum sampling rate with eight PT 100 sensors is every minute
8. DaqPRO displays readings in real time at rates up to 1/s
9. DaqLab displays online readings at rates up to 100/s

#### 2.Sampling points:

Increasing the number of active inputs limits the number of sampling points one can choose. The following condition must be always satisfied:

$$\text{Number of samples} \times \text{Active Inputs} \leq \text{Memory}$$

DaqPRO's memory is sufficient for 512,000 samples.

The table below lists the maximum number of sampling point according to the number of sensors:

Number of sensors	Maximum number of sampling points
1	512,000 (exact number: 522,752)
2	256,000 (exact number: 260,608)
3	128,000 (exact number: 129,536)
4	128,000 (exact number: 129,536)
5	64,000
6	64,000
7	64,000
8	64,000

#### 3.Continuous sampling

- Continuous sampling is possible up to a maximum sampling rate of 1/s.
- The data must be presented in a display mode other than graphic.

# Chapter 2

## Working with DaqLab

### 2.1. Install the Software

#### 2.1.1. System Requirements

To work with DaqLab, your system should be equipped with the following:

##### 1. Software

- Windows 98 or later
- Internet Explorer 5.0 or later (you can install Internet Explorer 5 when you install DaqLab, since it ships with the product)

##### 2. Hardware

- Pentium 200MHz or higher
- 32 MB RAM (64 MB recommended)
- 10 MB available disk space for the DaqLab application (50 MB to install the supporting applications)

#### 2.1.2. Installation

1. Close all programs
2. Insert the CD labeled DaqLab into your CD-ROM drive

Installation will begin automatically. Simply follow the on-screen instructions to continue

In case **auto run** is not working, open **My Computer** and click on the CD drive folder (**d:** drive in most cases) and double-click on the setup icon, then follow the on-screen instructions.

**To uninstall the software:** From the Start menu select Settings and click on Control Panel, then use the Add/Remove programs function to remove the DaqLab application.

When updating the software, always remove the old version before starting a new installation.

**To install the USB driver:**

1. Insert the CD into your CD drive. If Installation begins automatically (and you have already installed DaqLab), click Cancel to stop installation
2. Connect the DaqPRO to a USB port on your PC and turn the DaqPRO on. Windows will automatically detect the new device and open the **Add New Hardware Wizard**
3. Select **Specify the location of the driver**, then click **Next**
4. Select **Search for the best driver for your device**, then check the **Removable Media** checkbox, and then click **Next**

Windows will automatically detect and install the necessary software.

**Note to the Windows XP user** – if the found New Hardware wizard prompts you to a Hardware Installation dialog:

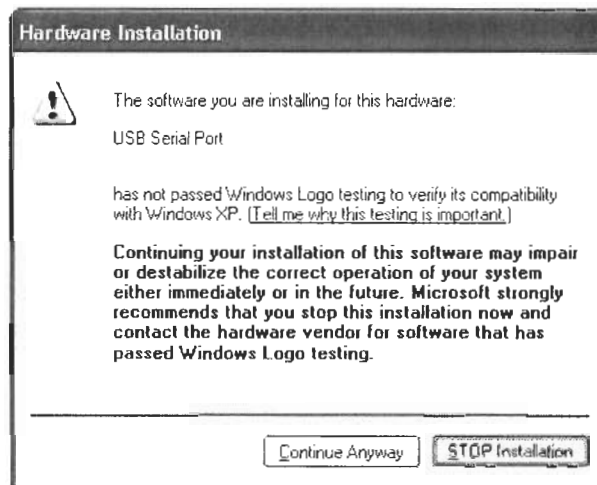

Just click **Continue Anyway** to proceed.



## 2.2. Overview

### 2.2.1. *DaqLab On-screen Layout*

DaqLab is a comprehensive program that provides you with everything you need in order to collect data from the DaqPRO display the data in graphs, meters and tables and analyze it with sophisticated analysis tools.

The program includes three windows: A graph window, table window, and a navigation window called the Data Map. You can display all three windows simultaneously or in any combination.

The most commonly used tools and commands are displayed on two toolbars. Tools that relate to all aspects of the program and tools that control the DaqPRO are located in the main (upper) toolbar. Tools specific to the graphs are located on the graph (lower) toolbar.

### 2.2.2. *Working with Projects*

Every time you start a new recording, DaqLab automatically creates a new project file. All the information you collect and process for a given session is stored in a single project file. Each of these files contain all the data sets you collect with the DaqPRO, the analysis functions you've processed, specific graphs you've created, and the DaqLab settings for the recording.

**Note:** all data sets in a single project must be with the same sampling rate.

### 2.2.3. DaqLab Window Layout

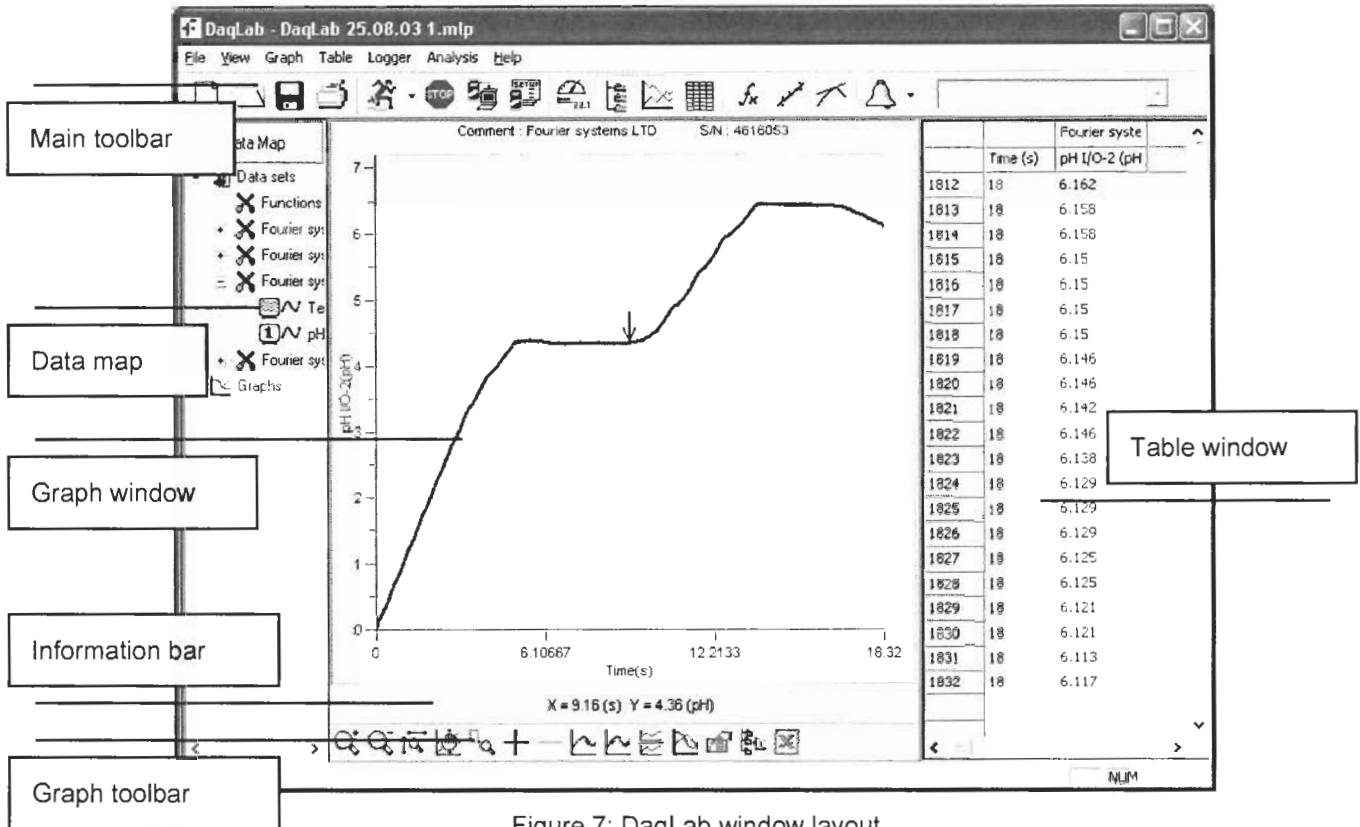

Figure 7: DaqLab window layout

## 2.3. Getting Started

### 2.3.1. Set up a Recording Session

#### 1. Prepare DaqPRO

1. Connect DaqPRO to the PC (see page 10)
2. Turn on DaqPRO
3. Plug in any external sensors
4. Open the DaqLab software

You can open DaqLab by double clicking its icon  on the desktop or from the start menu

#### 2. Setup the DaqPRO

1. Click **Setup Wizard**  on the main toolbar
2. Follow the instructions in the **Setup Wizard** (see page 52)

#### 3. Start Recording

Click **Run**  on the toolbar to start recording.

If the recording rate is 100 measurements per second or less, DaqLab automatically opens a graph window displaying the data in real time, plotting it on the graph as it is being recorded. If the recording rate is higher than 100/s, the data will be downloaded and displayed automatically, once the data recording is finished.

You can stop recording anytime by clicking **Stop**  on the toolbar.

### 2.3.2. *Data recording options*

To set the behavior of the data display when you start a new recording session, click on the **down arrow** next to the **Run** button  , and select one of the following:

#### 1. Single measurement

DaqLab will open a new project file every time you start a new recording session.

#### 2. Replace

DaqLab will display the new data set in place of the old set. The project's old data sets will still be available in the same project file. They will be listed in the Data Map and you can add them to the display at any time

#### 3. Add

DaqLab will add the new data set to the graph in addition to the old ones.

**Note:** A maximum of 8 data sets can be displayed on the graph at the same time.

### 2.3.3. *Download Data*

Whenever data is received from the DaqPRO, it is accumulated and displayed automatically by DaqLab. There are two modes of communication: online and offline.

#### Online communication

When DaqPRO is connected to the PC and programmed to run at sampling rates of up to 100/s, DaqPRO transmits each data sample immediately, as it is recorded, to the PC. The software thus displays the data in real-time in both the graph window and the table window.

When DaqPRO is connected to the PC and programmed to run at a sampling rate of 500/s or higher, data is accumulated in DaqPRO's internal memory. This data is not transmitted to the PC until the recording period has ended, when the data is automatically downloaded to the PC and displayed.

#### Offline data logging

- To download data that was recorded offline, or while DaqPRO was not connected to a PC, connect DaqPRO to the computer, run the DaqLab program and click **Download**



on the main toolbar. This will initiate the Post-Recording Data Transfer

communication mode. Once the transfer is complete, the data will be displayed automatically in the graph window and in the table window. If there are several files stored in the DaqPRO, the first download will bring up the most recent file; the second download will bring up the earliest file, the third download will bring up the second earliest file, and so on.

- If you are logging offline at rates of up to 1/s, you can connect DaqPRO to the computer and download the accumulated data at anytime. Apart from during the transfer period, the data will be downloaded without interrupting the logging process.
- To download a particular file, choose **Selective download** from the **Logger** menu, then select the file's number in the Download dialog.
- Click **Cancel** in the Download progress window at any time to stop downloading the data.

#### 2.3.4. Save Data

Click **Save**  on the main toolbar to save your project. This will save all the data sets and graphs under one project file.

Saving the project will also save any special formatting and scaling you did.

If you made any changes to a previously saved project, click **Save** to update the saved file or select **Save as...** from the file menu to save it under another name.

#### **Note:**

To delete a specific data set, a graph or a table from the project, use the Data Map (see page 49)

To remove unwanted data from a specific data set, apply the crop tool (see page 83).

#### 2.3.5. Open a File

1. Click **Open**  on the main toolbar
2. Navigate to the folder where the project is stored
3. Double click the file name to open the project

DaqLab opens the project and displays the first graph on the graph list. If the project does not include saved graphs, the file opens with an empty graph window. Use the Data Map (see page 49) to display the desired data set.

### 2.3.6. *Create a New Project*

There are three ways to create a new project:

1. Open the DaqLab program, which will open a new file each time
2. When working in Single Measurement mode, a new project is opened every time you click on the **Run** button to start a new recording

3. Any time you click **New** button  on the toolbar

### 2.3.7. *Import data*

Any file that is in comma separated values text format (CSV) can be imported into DaqLab

To import a CSV file:

1. Click **File** on the menu bar, then click **Import CSV file**
2. In the dialog that opens, next to **Look in**, navigate to the drive and folder that contains the CSV file
3. Select the file
4. Click **Open**

#### **Tips:**

To create a text file in a spreadsheet:

1. Open a new spreadsheet
2. Enter your data according to the following rules:
  - a) The first row should contain headers. Each header includes the name of the data set and units in brackets, e.g. Distance (m)
  - b) The first column should be the time. The time interval between successive rows must match the time intervals accepted by DaqLab. You can export DaqLab files to Excel to learn about these time formats

See for example the table below:

	A	B	C
1	t(s)	x(m)	y(m)
2	0	0	5
3	0.1	0.95	4.05
4	0.2	1.8	3.2
5	0.3	2.55	2.45
6	0.4	3.2	1.8
7	0.5	3.75	1.25
8	0.6	4.2	0.8

3. On the **File** menu, click **Save As**
4. In the **File name** box, type a name for the workbook
5. In the **Save as type** list, click the **CSV** format
6. Click **Save**

To import files that were previously exported from DaqLab open DaqLab and import the file as described above as they are already in CSV format.

### 2.3.8. *Date format settings*

To set the way data will be displayed on screen click **Date format settings** to open the Date format settings dialog:

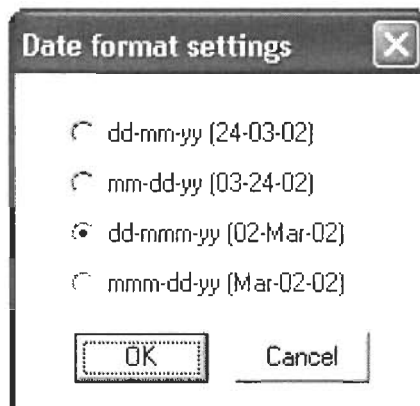

Click the desired option, then click **OK**.

### 2.3.9. *Print*

#### 1. Print a graph

1. Click **Print**  on the main toolbar
2. Select the **Graph 1** option (when in split graph mode you can choose between Graph 1 and Graph 2)
3. Click **Print** to open the print dialog
4. Click **OK**

DaqLab will print exactly what you see in the graph display.



## 2. Print a table

1. Click **Print**  on the main toolbar
2. Select the **Table** option
3. If you want to print only a specific range, uncheck the **Print all data** check box and type the desired row numbers into the **To** and **From** edit boxes
4. Click **Print** to open the print dialog
5. Click **OK**

DaqLab will print exactly what you see in the table display as well as the DaqPRO comment, serial number and the alarm level setup. Data that exceeds any of the alarm levels will be highlighted by arrows.

## 2.4. View the Data

### 2.4.1. Display Options

The DaqLab program's screen consists of three parts: the graph window, table window and Data Map window. You can display all three parts simultaneously (the default view) or any combination of the three.

The graph window is the main window by default and is displayed in the center of the application window.

In addition to these sections, you have the option to display an on-screen meter for each of the sensors (see page 48).

### 2.4.2. Graph Display

Click **Graph**  to display or hide the graph. The default graph display is the data set or sets plotted vs. time, but you can change the X-axis to represent any of the individual data sets (see page 44).



The graph usually displays all the data sets of a given recording, but you can use the Data Map to remove one or more of the sets from the graph (see page 49).

In order to keep the graph clear and simple, only two Y-axes are shown on the graph at once. If there are three curves in the graph, one of the Y-axes is hidden. In order to make this axis visible, select the corresponding plot with the cursor (see section 2 below).

You can identify the Y-axis by its color, which matches the plot color.

#### 1. Split graph view

DaqLab enables you to display your data in two separate graphs within the graph window.

1. Click **Split graph**  on the graph toolbar to split the graph window into two separate graphs
2. Click **Edit graph**  on the graph toolbar to open the Edit graph dialog
3. Choose which data sets to display on each of the graphs (or use the Data Map to do so – see page 49)

4. To return to the single graph display, click **Split graph**  a second time

## 2. The Cursor

You can display up to two cursors on the graph simultaneously.

Use the first cursor to display individual data recording values, to select a curve or to reveal the hidden Y-axis.

Use two cursors to display the difference between two coordinate values, to display the frequency of periodic data or to select a range of data points.

### To display the first cursor:

Double click on an individual data point or click **Cursor**  on the graph toolbar. You can drag the cursor with the mouse onto any other point on the plot, or onto a different plot. For finer cursor movements use the forward and backward keys on the keyboard.

The coordinate values of the selected point will appear in the information bar at the bottom of the graph window.

### To display the second cursor:

Double click again anywhere on the graph area or click **2<sup>nd</sup> Cursor** .

The information bar will now display the difference between the two coordinate values.

### To remove the cursors:

Double click anywhere on the graph area, or click **1<sup>st</sup> Cursor** a second time.

### To remove the 2<sup>nd</sup> cursor:

Click **2<sup>nd</sup> Cursor** a second time.

### To display the cursors in split graph mode:





To display the cursors on the upper graph, use the same method as for single graph mode.

To display the cursors on the lower graph, you must first remove them from the upper graph and then double click anywhere on the lower graph to display the first cursor. Double click a second time to display the second cursor, and double click a third time to remove the cursors.

## 3. Zooming

1. *To zoom in to the center of the graph*

1. Click **Zoom in**  on the graph toolbar

2. To reverse the operation, click **Zoom out**  on the graph toolbar
2. *To zoom in to a specific data point*
  1. Select the point with the cursor (see above)
  2. Click **Zoom in**  on the graph toolbar
  3. To reverse the operation click **Zoom out**  on the graph toolbar.
3. *To zoom in to a range*
  1. Select the range with both cursors
  2. Click **Zoom in**  on the graph toolbar
  3. To reverse the operation click **Zoom out**  on the graph toolbar
4. *To zoom in to a specific area*

Click **Zoom to selection**  on the graph toolbar and drag the cursor diagonally to select the area you want to magnify. Release the mouse button to zoom in to the selected area.

Click **Zoom to selection** a second time to disable the zoom tool.

#### 5. *Autoscale*

Click **Auto scale**  on the graph toolbar to view the full data display, or double click on an axis to auto scale that axis alone.

#### 6. *Manual scaling*

1. Click **Graph properties**  on the graph toolbar to open the Graph properties dialog
2. Select the **Scale** tab, and choose the axis you want to scale in the **Select axis** drop list

3. Uncheck the Autoscale check box and enter the new values in the edit box
4. Click **OK**

To manually scale a specific axis, right click on the axis to open its Properties dialog.

To restore auto scaling click **Autoscale** .

#### 7. *The stretch/compress axis tool*

Move the cursor onto one of the graph axes. The cursor icon changes to the double arrow symbol ( $\leftrightarrow$ ), indicating that you can stretch or compress the axis scale. Drag the cursor to the desired location. Repeat the procedure for the other axis if necessary.

Double click on the axis to restore auto scaling.

#### 4. Panning

Use the pan tool after zooming in to see any part of the graph that is outside the zoomed area.

To do this, click **Pan**  on the graph toolbar, then click anywhere on the graph and drag the mouse to view another area.

Click **Pan** a second time to disable the Pan tool.

#### 5. Edit the Graph

Use the Edit graph dialog to select which data sets to display on the graph's Y-axis and to change the X-axis from time, to one of the data sets.

1. Click **Edit graph**  on the graph toolbar to open the Edit graph dialog:

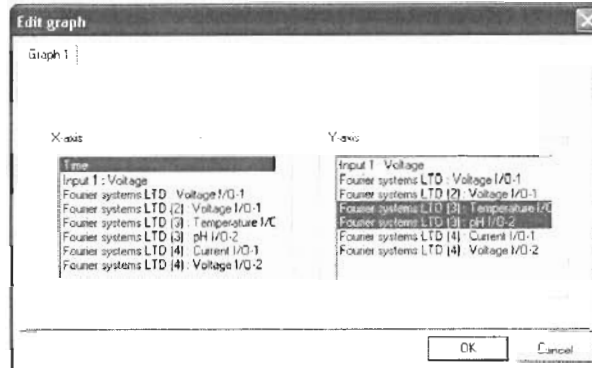

Figure 8: Edit graph dialog

2. To select a data set to display on the Y-axis, click on the data set's name in the **Y-axis** list. To display more than one curve, click on the data sets you want
3. A list entry that begins with a DaqPRO comment denotes a recorded data set. A list entry that begins with an input number denotes the next recording and will be displayed on the graph the next time you start a recording
4. To deselect a data set, click on it a second time
5. To select a data set for display on the X-axis, click on the data set's name in the **X-axis** list. You can only select one data set at a time for the X-axis
6. Click **OK**

## 6. Display alarm levels

1. Click **Display alarm level**  
2. Select the sensor you wish to display from the **select sensor** drop list  
 

To display alarm levels on graph 2 in split graph mode click the down arrow next to the button and select graph 2.

## 7. Format the graph

You can change the data line's color, style and width. You can also add markers that represent the data points on the graph and format their style and color.

The color of the Y-axis matches the corresponding plot's color and will automatically change with any change made to the color of the corresponding plot.

1. Click **Graph properties**  on the graph toolbar to open the Graph properties dialog
2. Select the **Lines** tab, and then select the plot or axis you want to format in the **Select plot** drop list
3. From here you can format the line's color, style and width, as well as the markers' color and style. To remove the line or the marker, uncheck the corresponding **Visible** check box
4. Click **OK**
5. To restore the default formatting, click **Restore default**

#### 8. Change the graph's units and its number format

1. Click **Graph properties**  on the graph toolbar to open the graph properties dialog
2. Select the **Units** tab, and then select the plot or axis you want to format in the **select plot** drop list
3. Choose the prefix option you want
4. Select the desired number of decimal places
5. To display numbers in scientific format, check the **Scientific** check box
6. Click **OK**

#### 9. Add a graph to the project

DaqLab displays new data in the graph window every time you start a new recording. You can always display previous data using the **Edit graph** dialog or by double-clicking on the data's icon in the **Data**

**Map.** If you want to save a graph that you created to your project, or to update a saved graph with changes you made, use the **Add to project** tool:

Click **Add to project**  on the graph toolbar.

### 2.4.3. *The Table Display*

Click **Table**  to display or to remove the table window.

The data in the table always matches the data that is currently displayed on the graph.

When you start a new recording, DaqLab displays the new data in the table as well as on the graph.



## Formatting the table

### 1. *Changing column width*

Drag the boundary on the right side of the column heading until the column is the desired width.

### 2. *Changing row height*

Drag the boundary below the row heading until the row is the desired height.

### 3. *Formatting the fonts*

1. Click **Table** on the menu bar, then click **Properties**
2. Select the **Font** tab
3. Format the font, as well as the font's style and size
4. Click **OK**

### 4. *Changing units and number format*

1. Click **Table** on the menu bar, then click **Properties**
2. Select the **Units** tab, and then select the plot you want to format from the **select plot** drop list
3. Choose the prefix option you want
4. Select the desired number of decimal places
5. To display numbers in scientific format, check the **Scientific** check box
6. Click **OK**



## 2.4.4. *Meters*

DaqLab enables you to view data in meters format on the screen (one meter for each sensor), with up to four meters showing at once. The meters can display live data while DaqLab is recording, or saved data when a saved file is replayed.

When a cursor is displayed, the meter shows the measured values that correspond to the time of the point at which the cursor is positioned.

There are three meter types: analog, bar and digital. The meter's scaling automatically matches the graph's scaling.

To set up the meters:

1. Click **Meter Setup**  on the main toolbar
2. Select the meter type, and the data set to be displayed
3. A list entry that begins with a graph number denotes a displayed data set. A list entry that begins with an input number denotes the next recording, and will be displayed on the meter the next time you start a recording
4. Repeat this procedure for up to four meters
5. To remove the meters click **Meter Setup** , and click **Remove all**

### 2.4.5. Data Map

Click **Data Map**  to display or remove the Data Map.

The data map is a separate window that displays the list of data sets that were recorded or downloaded in the current session, as well as the lists of all the saved graphs. Use the Data Map to navigate through the available data sets and to keep track of the data that is being displayed in the graph window.

**Note:** The data in the table always matches the data that is currently displayed on the graph.

#### 1. Control the display with the Data Map

The items in the Data Map are sorted into two main categories:

- Data sets (including analysis functions)
- Saved graphs

Double click on a category to bring up the full list. Double click a second time to collapse the list. You can also use the plus (+) and minus (-) signs next to the icons to expand or collapse the categories.

The Data sets' list expands to sub-categories of recorded data and functions. To display the complete list of measurements, or the complete list of analysis functions performed on the measurements for any individual data capture, double click the file's icon or click the plus sign (+) next to it.

To collapse a list under an individual data capture, double click the corresponding icon or click the minus sign (-) next to it.





















To display a data set or a saved graph double click its icon. Double click a second time to remove it. You can also use a shortcut menu to display or remove a data set from the graph. Simply right-click an icon, then click **display on graph #1** or **display on graph #2**.

To delete an individual item from the Data Map and from the project, right-click on its icon and click

**Delete**. To permanently delete the item, click **Save**  on the main toolbar.

To remove all data sets from the Data Map, right-click the Data sets icon  and click **Clear All Data**.

## 2. Understanding Data Map icons

	Data sets list
	Functions – includes all the analysis functions of the project
	Individual function – currently not on display
	Individual function – currently displayed on graph 1
	Individual function – currently displayed on graph 2
	Individual function – currently displayed both on graphs 1 and 2
	Function
	data capture – includes all recorded data of the recording
	Individual data set – currently not on display
	Individual data set – currently displayed on graph 1
	Individual data set – currently displayed on graph 2
	Individual data set – currently displayed both on graphs 1 and 2
	Raw data
	List of saved graphs
	Saved graph – data sets vs. time
	Saved graph – data sets vs. data set
	Graph currently not on display
	Graph currently displayed on graph 1
	Graph currently displayed on graph 2
	Graph currently displayed both on graphs 1 and 2

## 2.4.6. *Export Data to Excel*

Click **Export to Excel**  on the graph toolbar to export the data that is currently displayed on the graph to Excel. DaqLab will then open a new Excel workbook displaying the data as well as the DaqPRO comment, serial number and the alarm level setup. Data that exceeds any of the alarm levels will be highlighted by arrows.

### **Export file settings**

If DaqLab fails to export the data properly, try to change the export file settings:

1. Click **File** on the menu bar, then click **Export file settings**
2. Check the Ignore regional settings check box
3. Click **OK**

## 2.4.7. *Copy the Graph as a Picture*

You can copy the graph to the clipboard as a picture and then paste it to other Windows programs such as Word or PowerPoint:

1. In the Graph menu, click **Copy graph**
2. Open the destination file
3. In the destination file, right click and select **Paste**

## 2.5. Program DaqPRO

### 2.5.1. Setup

#### 1. Quick setup

Use the Setup wizard to guide you through the setup process.

1. Click **Setup wizard**  on the main toolbar to open the setup wizard:

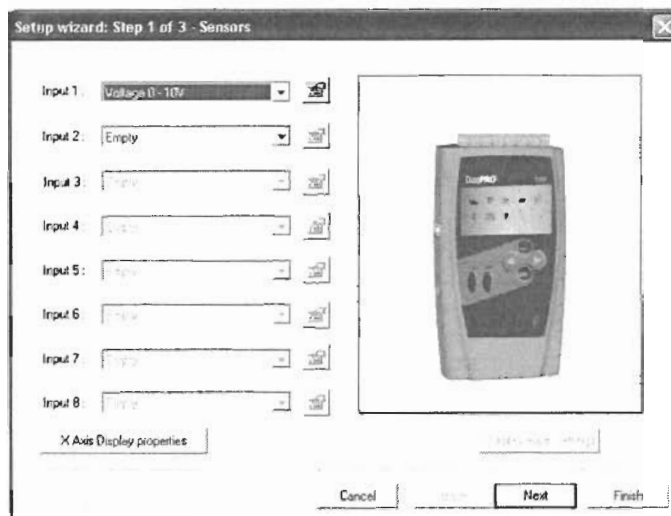

Figure 9: Setup wizard step 1 of 3

The first step is to assign sensors to each input. Select the sensors you are using from the corresponding input drop lists.

To set alarm levels and alarm action click Display alarm settings (see page 54 for detailed alarm setup)

2. Click **Next** to move to the second step:

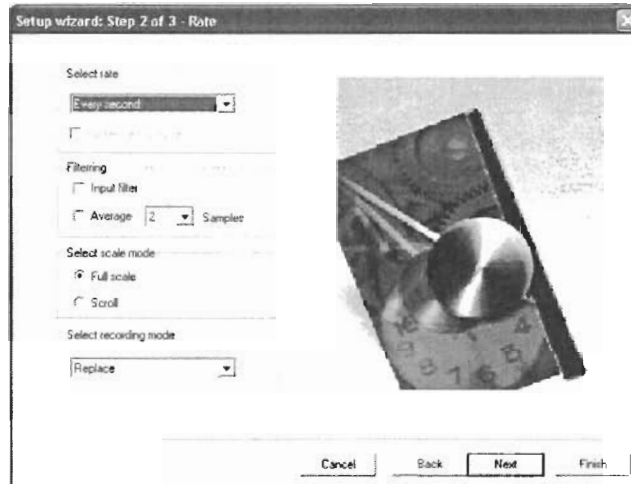

Figure 10: Setup wizard step 2 of 3

3. Select the desired recording rate in the **Select rate** drop list
4. Select the **Scroll** option if you want the graph window to scroll as the data recording progresses
5. Select the desired data recording mode in the **Select recording mode** drop list
6. Click **Next** to move to the third step:

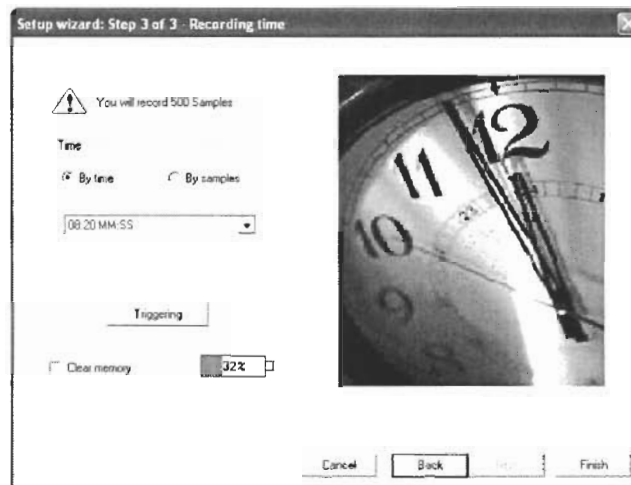

Figure 11: Setup wizard step 3 of 3

7. Select the desired length of the recording period in the **Select recording time** drop list. The recording period is displayed as a unit of time by default. To display the recording period as the number of recording samples, select the **By samples** option. The number of samples is calculated with the following formula:

$$\text{Total recording samples} = \text{Recording rate} \times \text{Recording period}$$

8. To start the data recording only when a specific time or measurement condition has been met click **Triggering** to open the triggering dialog (see page 57)
9. Click **Finish** to complete the setup and to send the setup command to the DaqPRO

## 2. Alarm setup

You can setup alarm levels and output for each sensor input individually in the first step of the **Setup wizard**:

1. Click **Setup Wizard**  on the main toolbar to open the setup wizard
2. Click **Display alarm settings** to show the alarm controls:

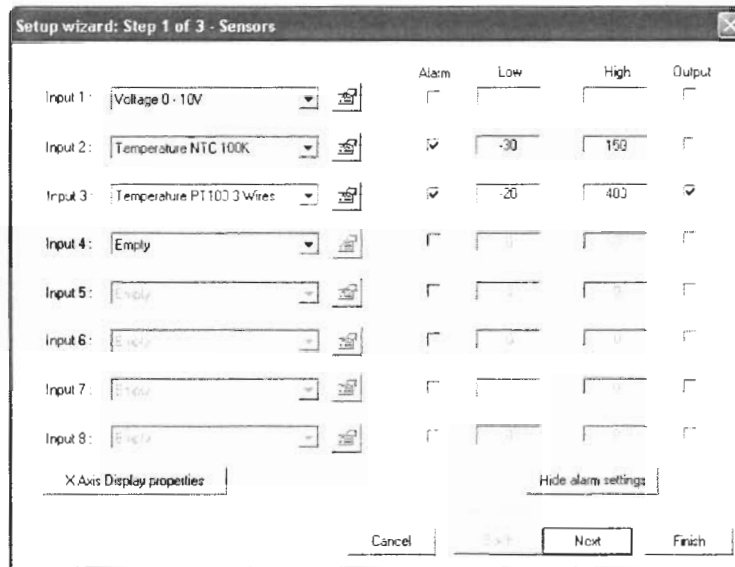

Figure 12: alarm settings

3. Check the checkbox or checkboxes near the inputs you want to activate the alarm
4. Type in Low or/and High alarm levels
5. If you want a sensor or sensors to activate the alarm output check the corresponding Output checkbox or checkboxes
6. Click **Next** to proceed to step 2 of the setup wizard or click **Finish** to complete the alarm setup

See page 13 to learn more on alarms and alarm output.

You can set DaqLab to display the alarm levels on the graph window (see page 45)

### 3. Low pass filter

To filter out 50/60Hz line noises use the low pass RC input filter:

Check the **Input filter** checkbox in step 2 of the Setup wizard

**Note:** We strongly recommend to use the filter with low output sensors like 50mV voltage measurements and thermocouples.

The low pass filter is applied to all inputs except for 24mA current measurements



#### 4. Averaging

Use this option to reduce random noises. DaqPRO replaces every data sample with the average of the last pre-set number of samples

To apply averaging:



Check the **Averaging** checkbox in step 2 of the Setup wizard, and select the number of samples to average from the drop list

#### 5. Battery level

A battery level indicator is displayed in step 3 of the Setup wizard. The indicator shows the remaining working hours as a percent of the battery's life (approximately 40 hours between charges), before it should be recharged.

#### 6. Presetting the display

You may want to define the graph's settings, such as formatting and scaling the graph and selecting the axes, and to define the meters' settings prior to beginning a recording session. You can define the settings of each sensor input individually in the first step of the **Setup wizard**:

1. Click **Setup Wizard**  on the main toolbar to open the setup wizard
2. Click **Properties**  next to the input you want to set
3. Click the **Display properties** tab
4. Select a measurement from the **Select measurement** drop list
5. Select the graph or graphs in which you would like to display the data, from the **Display on graph** drop list
6. Select a meter in the **Meter type** drop list if you want to display the data in a meter as well as on the graph
7. Format the line and markers in the **Plot** section
8. If you want a specific scale, uncheck the **Auto scale** check box and enter the desired minimum and maximum values of the axis
9. Click **OK**

## 7. Preset the graph's X-axis

1. Click **X-Axis display properties** in the first step of the Setup wizard to open the dialog:

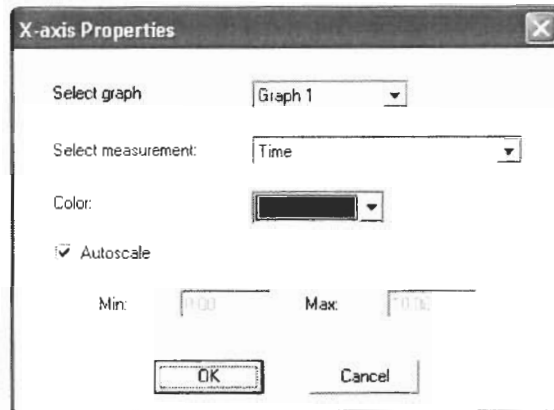

Figure 13: X-axis properties dialog

2. Select the graph you wish to modify
3. Select the measurement you'd like to display on the X-axis
4. If you want a specific scale, uncheck the **Auto scale** check box and enter the minimum and maximum values of the axis
5. Click **OK**

## 8.Triggering

To start the data recording only when a specific time or measurement condition has been met, click **Triggering** in step 3 of the Setup wizard to open the triggering dialog:

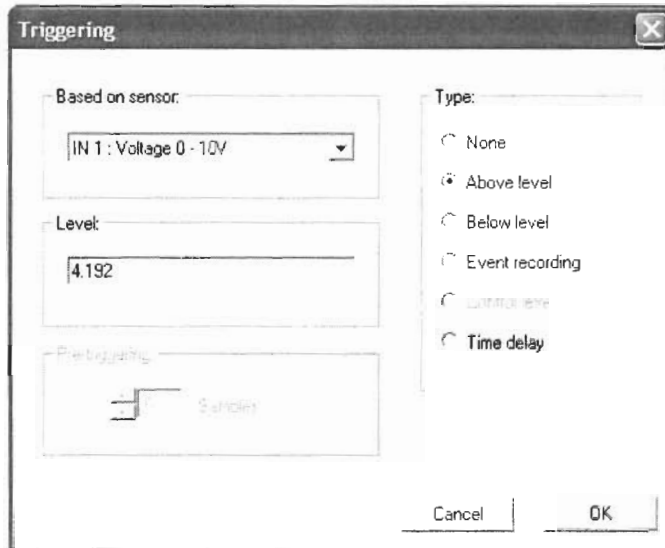

Figure 14: Triggerring dialog

1. Select the triggering sensor in the **Based on sensor** drop list
2. Choose one of the following from the **Type** options:

- **None** – Trigger is disabled
- **Above level** – Start logging only once the measured value is **HIGHER** than the trigger level.
- **Below level** – Start logging only once the measured value is **LOWER** than the trigger level.
- **Event Recording** – This function enables you to record the exact time and date at which a certain phenomenon occurred: The trigger level set for this option is actually a threshold setting. Each time the threshold is crossed, DaqPRO will record the exact time and date of the occurrence, and will continue to do so until the desired number of samples has been obtained.

When logging has ended download the data to the PC (if DaqPRO is already connected to the PC it will be done automatically). The event list will be displayed in the table window. You can now save the list, export it to Excel or print it.

**Note:** The trigger condition must be fulfilled for at least 300 $\mu$ S.

- **Time delay** – This trigger type enables you to set a timer that will start the logging after a predetermined amount of time. After setting the trigger to Timer Delay, click the down arrow on the **Level** combo-box, and select from the 17

different time options. The timer will start its countdown when you click **RUN**, and the actual recording will start once the countdown has ended.

3. Type in the desired trigger level in the **Level** edit box
4. Click **OK**

**Note:** When you turn off DaqPRO, it will save the setup for the next session.

### 2.5.2. Start Recording

Click **Run**  on the main toolbar. Click the **down arrow** to change the recording mode.

### 2.5.3. Stop Recording

Click **Stop**  on the main toolbar

### 2.5.4. Clear DaqPRO's Memory

To erase all data currently stored in the DaqPRO, click **Clear memory** in the **Logger** menu (DaqPRO must first be connected to the PC).

### 2.5.5. Adding comment to DaqPRO

You can add a comment to each DaqPRO. The comment will serve as a name to identify the specific DaqPRO in addition to its serial number. Every time data is being downloaded from a DaqPRO, its comment and the serial number will be displayed in the graph title and on the corresponding icon in the Data Map. To display the comment on DaqPRO's LCD select the **System information** menu (see page 22)

The comment and the serial number will also be displayed in prints and exported files.

**Note:** the comment can include up to 32 characters.

To add a comment:

1. Connect DaqPRO to the PC
2. Click **Logger** on the menu bar, then click **Set comment**

3. Click the **Comment** edit box and type a comment (e.g. its location)
4. Click **OK** to upload the edited notes to DaqPRO

### 2.5.6. *Edit DaqPRO's Notes*

1. Connect DaqPRO to the PC
2. Select **Edit notes** from the **Logger** menu to open the **Notes** dialog with the DaqPRO's current notes downloaded to the window

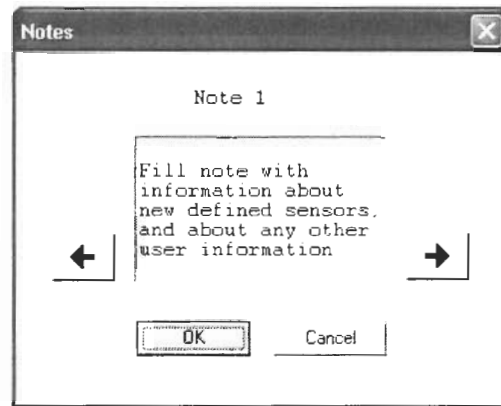

Figure 15: Edit notes dialog

3. From this dialog, you can edit, delete, or write new notes

**Note:** A note is limited to 140 characters and a maximum of 3 notes can be stored in DaqPRO at any time.

4. Use the arrow buttons to move to the next note, or to the previous one
5. Click **OK** to upload the edited notes to DaqPRO

### 2.5.7. *Temperature units*

To select between Fahrenheit (°F) and Celsius (°C) temperature units:

Click **Logger** on the menu bar, point to **Temperature units** and then select the desired units

## 2.5.8. Calibrating the Sensors

### 1. Calibration options

DaqPRO ships fully calibrated. However, DaqLab enables you to calibrate any of the DaqPRO sensors except for the internal temperature sensor, which doesn't need calibration. The calibration parameters are sent to DaqPRO and stored in its memory.

#### Tips:

- Prior to any calibration procedure you must restore factory defaults
- Calibrating a sensor type applies to all inputs
- Calibrating the PT 100 2 wires sensor applies also to PT 100 3 wires except for fine offset calibration
- Prior to calibrating any of the thermocouple sensor types, calibrate the Voltage 50mV sensor as this will set the gain (slope) of all thermocouple sensor types
- The internal temperature sensor needs no calibration

DaqLab employs three different calibration methods **Two-point calibration**, **Offset calibration** and **Zero calibration**. When selecting a sensor type to calibrate, DaqLab prompts you to the appropriate calibration procedure:

Sensor	Type	Calibration method
Current	0 – 24mA	Two-point calibration
Temperature	NTC 10K	Zero calibration
Temperature	NTC 100K	Zero calibration
Temperature	PT-100 2 wire	Two-point calibration
Temperature	PT-100 3 wire	Two-point calibration*
Temperature	Thermocouple J	Offset calibration
Temperature	Thermocouple K	Offset calibration
Temperature	Thermocouple T	Offset calibration
Voltage	0 – 10V	Two-point calibration
Voltage	0 - 50mV	Two-point calibration

#### Two-point calibration

The two-point calibration sets the gain (slope) and offset (intercept) of the sensor's conversion function.

Use the two point calibration to calibrate the voltage and current sensors and the PT100 temperature sensors.

\* To calibrate the PT100 3 wire, first calibrate the PT100 2 wire as the slopes of their conversion functions are identical. Then proceed to adjust the PT100 3 wire offset.

In some cases you may need to refine your calibration using the fine offset tuning tool.

#### **Offset calibration**

To calibrate the thermocouple temperature sensors: TC-J, TC-K and TC-T first calibrate the 50mV sensor type. That will set the slope for all thermocouple temperature sensors. Then proceed to adjust the offset using the Offset calibration technique.

#### **Zero calibration**

The zero calibration sets only the offset (intercept) of the sensor's conversion function.

Use the zero calibration to calibrate the NTC 10k and NTC 100k temperature sensors.

## **2. Calibration password**

To prevent accidental change of the calibration, the calibration procedure is protected by a password.

**The default password is: 1234**

**To change the password:**

1. Click **Logger** on the menu toolbar, and then click **Calibration**
2. Click **Change Password** to open the Change Password dialog box
3. Enter the current password in the **Current Password** edit box
4. Enter the new password in the **New Password** edit box
5. Enter the new password a second time in the **Confirm New Password** edit box to confirm your new password
6. Click **OK**

Note: The password must include at least 4 characters and is **case sensitive**.

## **3. Calibration procedure**

### **Two point calibration:**

**Measure two reference values**

1. Connect DaqPRO to the PC
2. Click **Logger** on the menu bar, then click **Calibrate sensors**
3. Enter the calibration password, then click **OK**
4. Choose a sensor from the **Select sensor** drop list and click **OK** to open the **Sensor calibration** dialog:

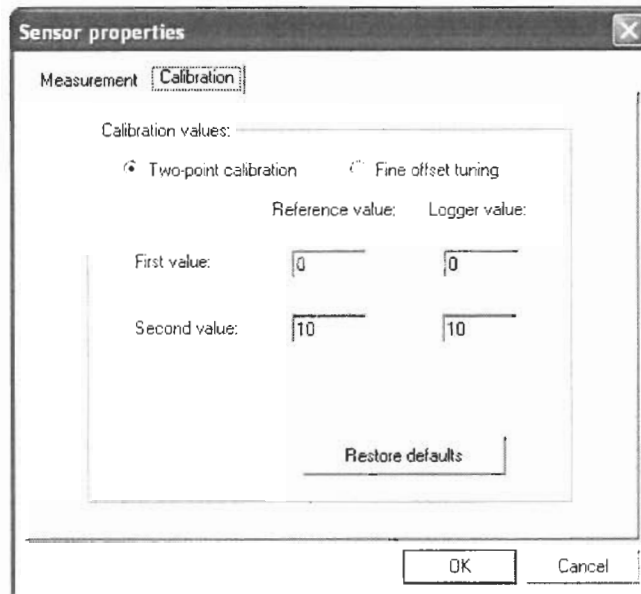

Figure 16: Two-point calibration dialog

Note: we strongly recommend calibrating using the values that appear in the two **Reference value** edit boxes

5. Click **Restore defaults**, then click **OK**
6. Measure two known reference values and record both the reference values and the values displayed by DaqLab



### Enter calibration values

1. Repeat steps 1 to 4 above
2. Select the **Two-point calibration** option
3. Enter a distinct reference value in each of the **Reference Value** edit boxes and the corresponding logger values in each of the **Logger Value** edit boxes (The logger values are the values displayed by DaqLab when measuring the two reference values)
4. Click **OK**

### Fine offset calibration

If, after the calibration procedure, DaqPRO still exhibits some offset value use the Fine offset tuning tool to correct it.

The offset value is the difference between the value displayed by DaqPRO and the reference value. For example if the calibrator is set to 0°C and DaqPRO reads 1°C the offset value is +1, but if DaqPRO reads -1°C then the offset value is -1.

1. Connect DaqPRO to the PC
2. Click **Logger** on the menu bar, then click **Calibrate sensors**
3. Enter the calibration password, then click **OK**
4. Choose a sensor from the **Select sensor** drop list and click **OK** to open the **Sensor calibration** dialog
5. Select the **Fine offset calibration** option
6. Enter the offset value
7. Click **OK**

The calibrated sensor parameters will be saved both in DaqPRO and DaqLab memories, so there is no need to calibrate DaqPRO every time you run the DaqLab program.

### Offset calibration:

Calibrating any of the thermocouple sensors comprises of two steps. First calibrate the 50mV voltage sensor to set the slope of the sensor's conversion function. Then use the calibration procedure described below to calibrate the sensor's offset.

## Measure two reference values

Before taking measurements you need to disable the temperature compensation both in DaqPRO and in the calibrator.

To disable the temperature compensation in DaqPRO:

Click **Logger** on the menu bar, point to **Thermocouple compensation**, and then click **Disable**.

Note: don't forget to enable the temperature compensation prior to normal operation of DaqPRO. One way to enable the temperature compensation is to turn DaqPRO off and on again. Another way is via DaqLab: Click **Logger** on the menu bar, point to **Thermocouple compensation**, then click **Enable**

To take two reference measurements:

1. Connect DaqPRO to the PC
2. Click **Logger** on the menu bar, then click **Calibrate sensors**
3. Enter the calibration password, then click **OK**
4. Choose a sensor from the **Select sensor** drop list and click **OK** to open the **Sensor calibration** dialog:

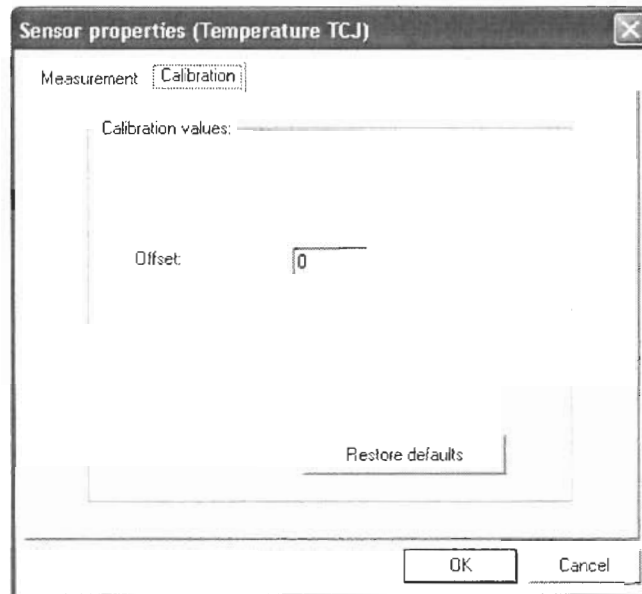

Figure 17: Offset calibration dialog

5. Click **Restore defaults**, then click **OK**
6. Measure two known reference values and record both the reference values and the values displayed by DaqLab. Calculate the offset values

The offset value is the difference between the value displayed by DaqPRO and the reference value. For example if the calibrator is set to 0°C and DaqPRO reads 1°C the offset value is +1, but if DaqPRO reads -1°C then the offset value is -1.

#### **Enter calibration values**

1. Repeat steps 1 to 4 above
2. Enter the offset value in the **Offset** edit box (in case the two offset values are not identical enter the average of the two values)
3. Click **OK**

#### **Zero calibration:**

1. Connect DaqPRO to the PC
2. Click **Logger** on the menu bar, then click **Calibrate sensors**
3. Enter the calibration password, then click **OK**
4. Choose a sensor from the **Select sensor** drop list and click **OK** to open the **Sensor calibration** dialog:

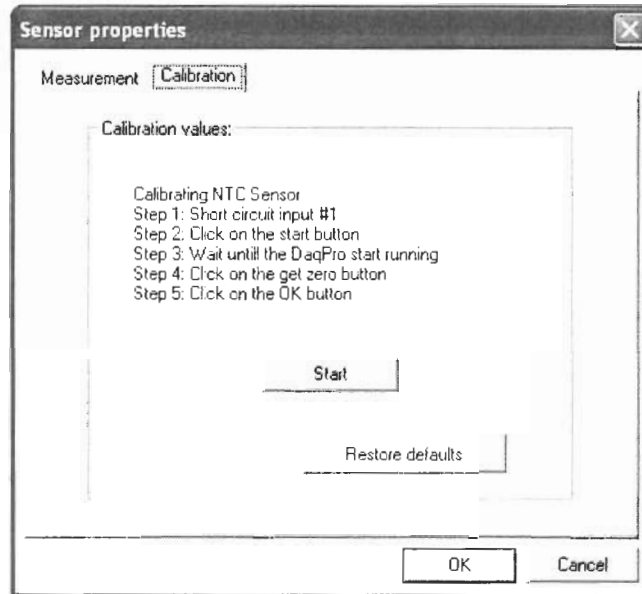

Figure 18: Zero calibration dialog

5. Click **Restore defaults**, then click **OK**
6. Repeat steps 1 to 4 above
7. Short circuit input 1
8. Click **Start**
9. Wait until DaqPRO begins recording
10. Click **Get zero**
11. Click **OK**

The calibrated sensor parameters will be saved both in DaqPRO and DaqLab memories, so there is no need to calibrate DaqPRO every time you run the DaqLab program.

### 2.5.9. Define a Custom Sensor

DaqLab enables the user to define custom sensors. This is a useful tool for when DaqPRO is communicating with many sensors from **different vendors**.

Any additional sensor that you would like to connect to DaqPRO must comply with the following restrictions:

- 1) The sensor's output must be either voltage in the range of 0 to 10V or current in the range of 0 to 24mA.
- 2) The sensor Transfer Function (sensor output voltage changes vs. the sampled phenomenon changes) must be a linear Transfer Function.

#### 1. To define a new sensor:

1. Connect DaqPRO to the PC
2. Click **Logger** on the menu bar, then click **Define new sensor** to open the Define new sensor dialog:

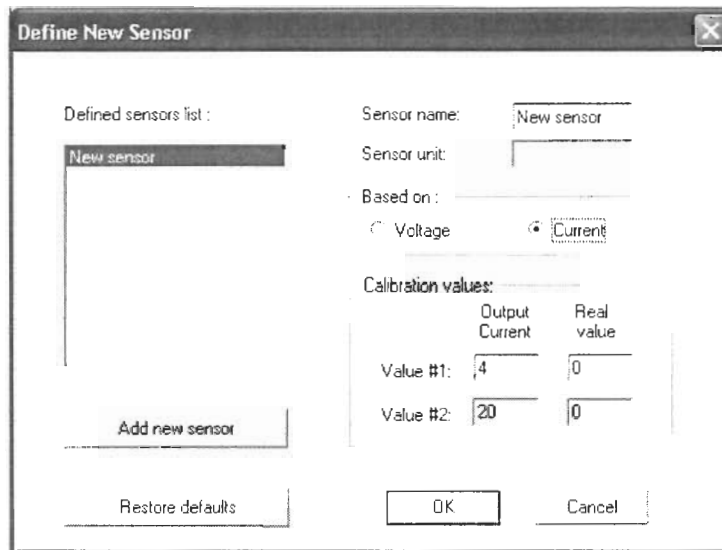

Figure 19: Define new sensor dialog

3. Click **Add New Sensor**
4. Select a **Based on** option (depending on whether your sensor's output is 0 to 10V or 4 to 24mA)

5. Type in a sensor name and a sensor unit
6. Type in two calibration values (two real values and the corresponding output values of the sensor)
7. Click **OK**

DaqPRO will send the definition to DaqPRO and will add the new sensor to the sensor list.

## 2. To use the custom sensor:

1. Plug the custom sensor into DaqPRO
2. Set up DaqPRO using the Setup Wizard (see page 52) and select the sensor from the sensor list next to the corresponding input
3. Proceed with the setup as you would normally do

## 3. Working with 4-20mA transducers

***As the DaqPRO internal operation voltage is +5V having a voltage over 6V on the input can cause a malfunction or give wrong readings when sampling other inputs.***

To avoid this situation the DaqPRO tests all inputs before starting a logging session and declares "Over Voltage" if a certain input is over 6V.

To work with 4-20mA transducers which have a supply voltage greater than 6V:

1. Connect a 200-500 Ohm shunt resistor(200 Ohm resistor is supplied with the DaqPRO) in parallel to DaqPRO's input terminals as a constant load ( we recommend using the supplied terminals with built in, high accuracy, 200 Ohm shunt)
2. Define the sensor based on **Current (Shunt)**
3. In the **Shunt Resistor** edit box type in the resistor's value
4. Proceed to define the sensor as in the normal procedure

As an example, let's look at a 0-100bar 4-20mA transducer which has a supply voltage of 24V. We can define the sensor as:

$$4\text{mA} \Leftrightarrow 0 \text{ Bar}$$

$$20\text{mA} \Leftrightarrow 100 \text{ Bar}$$

So the definition parameters will be:

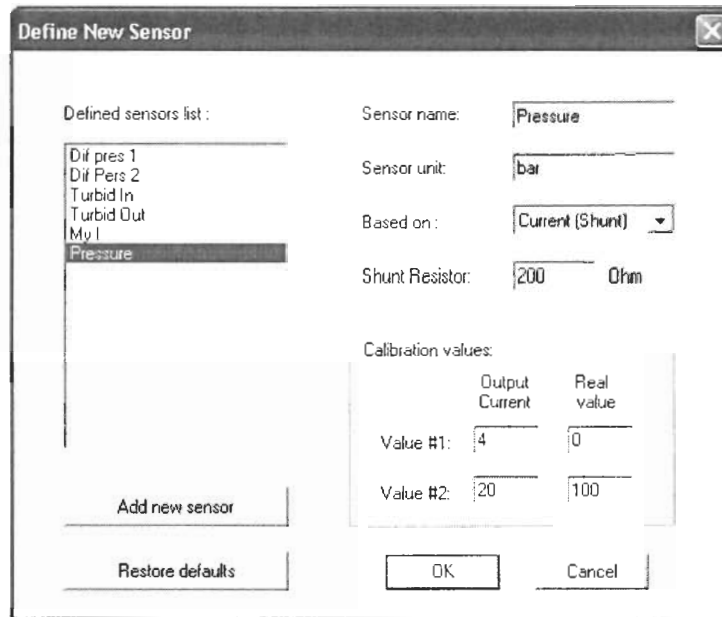

### 2.5.10. Communication Setup

Communication between the PC and DaqPRO takes place automatically whenever you send a command to DaqPRO. However, the Communication Setup dialog can be used for more advanced communication options.

1. Click **Logger** on the menu bar, and then click **Com setup**. DaqLab will display a dialog reporting what COM Ports are already in use, and which port is recommended for use with DaqPRO:

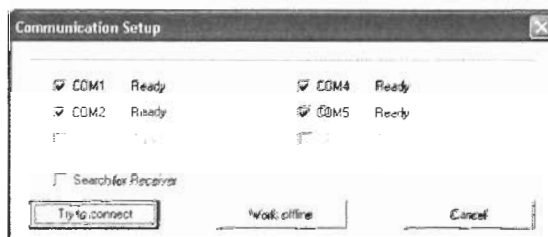

Figure 20: Communication setup dialog

2. Click **Try to connect** and DaqLab will try to communicate with DaqPRO. If communication is achieved, DaqLab will designate the selected port as DaqPRO's communication port.

You can override the DaqLab recommendation and choose the COM Port yourself by clicking the check box button to the left of the desired port, and clicking **Try to connect**.

**Note:** In case of any communication malfunction, please refer to the troubleshooting guide on page 87.

3. You can click **Work offline** if you wish to work without DaqPRO. While working offline, you can still open or import saved files to view and analyze them



## 2.6. Analyze the data

### 2.6.1. *Reading Data Point Coordinates*

Position the cursor (see page 42) on a point to display its coordinates on the information bar at the bottom of the graph window.

If more than one curve is displayed, and you want to read the Y coordinates of all of the curves simultaneously, bring up digital meters (see page 48) for each of the curves. When you position a cursor on one curve, the meters will show the corresponding Y-coordinates for the other curves.

### 2.6.2. *Reading the Difference Between two Coordinate Values*

Position one cursor on the first point and a second cursor on the second point to display the difference between the two coordinate values on the information bar at the bottom of the graph window

### 2.6.3. *Working with the Analysis Tools*

The analysis tools can only be applied to data sets that are displayed in the graph window.

1. Use the cursors (see page 42) to select the graph and the data range to which you want to apply the analysis.
2. Select the analysis function you wish to use.

The analysis function will be added onto the graph, with the exception of the smoothing (averaging) function, which will replace the original data set.

### 2.6.4. *Smoothing*

The smoothing tool is very useful in reducing random "noises", especially if you want to apply any analysis functions to the data. The smoothing process replaces every data point with the average of its neighboring points.

1. Use the cursor to select the function on the graph that you want to smooth
2. Click **More smoothing**  on the graph toolbar
3. You can repeat the procedure to further smooth the data

4. Click **Less smoothing**  to reduce the amount of smoothing

### 2.6.5. *Statistics*

Use the statistics tool to display statistics of a selected data set or a range of data.

The statistics include:

**Average** – The average of all the numbers in the range

**StDev.** – The standard deviation

**Minimum** – The smallest value in the range

**Maximum** – The largest value in the range

**Sum** – Adds all the numbers in the range

**Area** – The area between the graph and the x-axis in the range

**Samples** – the number of data points in the range

**Rate** – the recording rate

**To display statistics:**

1. Use the cursors to select the graph and the data range to which you want to apply the statistics
2. Click **Analysis** on the menu bar, then click **Statistics**

DaqLab will open a statistics window and will display the results in it

### 2.6.6. *Most Common Analysis Functions*

#### 1. Linear fit

Click **Linear Fit**  on the main toolbar to draw a line of linear least square fit

$$y = ax + b$$

and to display the line's equation

**Note:** If you want the automatic curve fit equation to start at  $t = 0$ , apply the crop tool before applying the linear fit (see page 83).

## 2. Derivative

Click **Derivative**  on the main toolbar to construct a graph in which each point is the slope of the 3 consecutive points on the source graph

## 3. Integral

Choose **Integral** from the **Analysis** menu to construct a graph in which each point is the integral of all the preceding points on the source graph

### 2.6.7. *The Analysis Wizard*

#### 1. Using the Analysis Wizard

The analysis wizard will guide you through the various analysis functions available in the DaqLab program. The analysis functions are grouped into three main categories: curve fit (regression), averaging, and mathematical and trigonometric functions.

To apply an analysis function to a data set:

1. Use the cursors to select the graph or data range to which you would like to apply the analysis
2. Click **Analysis Wizard**  on the main toolbar
3. Click a category tab:
  - a. Curve fit
  - b. Averaging
  - c. Functions

## 2. Curve fit

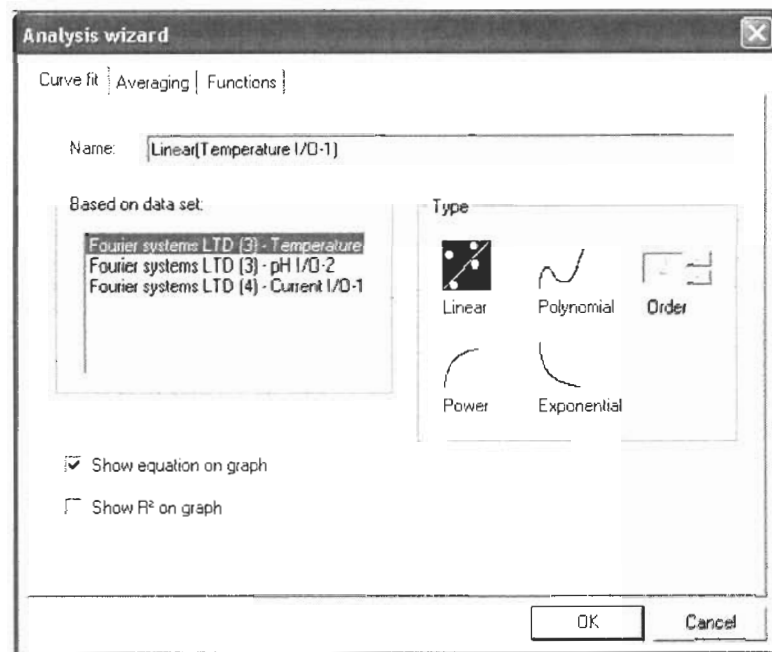

Figure 21: Analysis wizard – curve fit

1. Select a fit Type by clicking its icon (If you choose polynomial fit, select the order you want)
2. If you use the cursor to select a data set, it will be highlighted in the **Based on data set** list, but you have the option of selecting a different data set
3. Type a name in the **Name** box (optional - the default name includes both the function and the data set names)
4. Click the **Show equation on graph** check box to display the line's equation on the information bar
5. Click the **Show R<sup>2</sup> on graph** check box to display the correlation coefficient on the information bar
6. Click **OK**

**Note:** If you want the automatic curve fit equation to start at  $t = 0$ , apply the crop tool before any type of curve fitting (see page 83).

### 3. Averaging

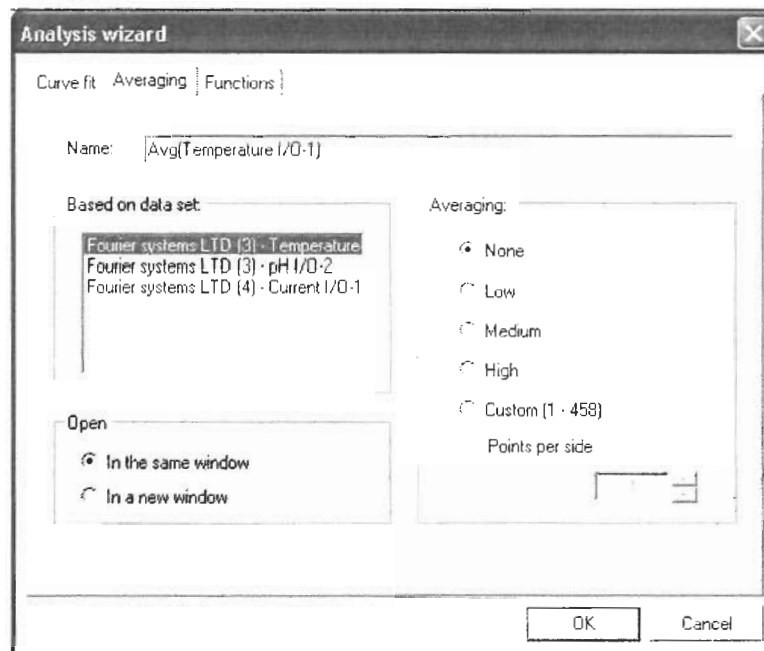

Figure 22: Analysis wizard – averaging

1. If you use the cursor to select a data set, it will be highlighted in the **Based on data set** list, but you have the option of selecting a different data set
2. Select an averaging option (if you choose custom averaging, choose the number of averaging points in the **Points** box)
3. Enter a name in the **Name** box (optional - the default name include both the function and the data set names)
4. Select an **Open** option
5. Click **OK**

## 4. Functions

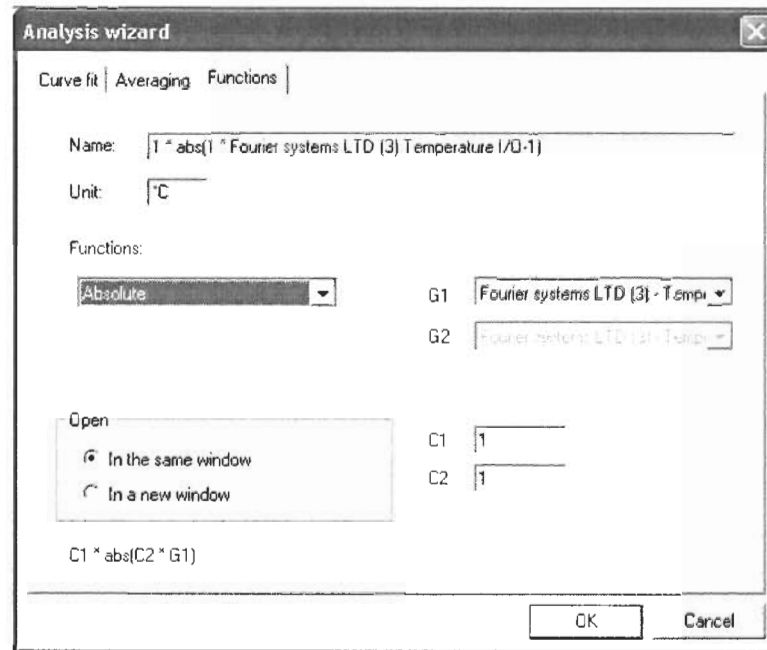

Figure 23: Analysis wizard – functions

1. Select a function from the **Functions** list. DaqLab displays the function's formula at the bottom of the dialog
2. If you use the cursor to select a data set, it will be highlighted in the **G1** drop list, but you have the option of selecting a different data set
3. If the analysis function involves two data sets, select the second data set from the **G2** drop list
4. Enter a constant in each of the **C1** and **C2** boxes (optional)
5. Enter a name in the Name box (optional – the default name includes both the function's formula and the data set name)
6. Enter a unit (optional)
7. Select an **Open** option

8. Click **OK**

### 2.6.8. Available Analysis Tools

This section includes a brief description of each of DaqLab's analysis functions

#### 1. Curve fit

**Linear**       $y = ax + b$

Draws a line of linear least square fit

**Polynomial**       $y = a_0x^n + a_1x^{n-1} + \dots + a_n$

Draws a line of polynomial least square fit (you must select an order between 1 and 6.)

**Power**       $y = \frac{a}{x^n}$

Draws a line of power least square fit

**Exponential**       $y = ae^{bx}$

Draws a line of exponential least square fit

DaqLab displays the curve fit equation and the correlation coefficient ( $R^2$ ) on the information bar below the graph

#### 2. Averaging

The average function replaces every point with the average of  $n$  neighboring points from both sides of the point

Low averaging:  $n = 5$ , Medium averaging:  $n = 11$ , High averaging:  $n = 41$

### 3. Functions

In the formulas below,  $G_1$  and  $G_2$  represent selected data sets, and  $C_1$  and  $C_2$  are constants that you can enter. The constant's default value is 1

**Absolute**       $y = C_1 |C_2 G_1|$

Draws a line of the absolute values of a data set

**Add**       $y = C_1 G_1 + C_2 G_2$

Draws a line of the addition of two data sets

**Arccosine**       $y = C_1 \arccos(C_2 G_1)$

Draws a line of the arccosine values of a data set (in radians). Arccosine is the angle whose cosine is  $C_2 G_1$ . The argument  $C_2 G_1$  must be between  $-1$  and  $1$ .

**Arcsine**       $y = C_1 \arcsin(C_2 G_1)$

Draws a line of the arcsine values of a data set in radians. Arcsine is the angle whose sine is  $C_2 G_1$ . The argument  $C_2 G_1$  must be between  $-1$  and  $1$ .

**Average**       $C_1 \cdot \{\text{average of } C_2 \text{ points around } G_1\}$

Replaces every point with the averaging of  $C_2$  neighboring points.

**Cosine**       $y = C_1 \cos(C_2 G_1)$

Draws a line of the cosine values of a data set. The argument  $C_2 G_1$  must be expressed in radians.



<b>Delta Y</b>	$y = G_1 - G_1(t = 0)$ <p>Draws a line of the difference between the Y-coordinate of every point and Y-coordinate of the first point. Use this function to move the data set along the Y-axis so that the point will intersect the Y-axis at the origin.</p>
<b>Derivative</b>	$y_n = \frac{y_{n+1} - y_{n-1}}{2\Delta t}, \Delta t = \frac{1}{\text{sampling rate}}$ <p>Draws a line of the slopes of every three consecutive points of a data set. For high recording rates and small <math>\Delta t</math>, this line may be very noisy, which is why smoothing the data set is recommended before applying the derivative function.</p>
<b>Divide</b>	$y = C_1 G_1 / C_2 G_2$ <p>Draws a line of the division of two data sets</p>
<b>Envelope (lower)</b>	<p>Lower envelope of <math>G_1</math> with tolerance of <math>C_1</math> points</p> <p>Draws a line that connects the minimum values of a data set. The tolerance defines the minimum distance (in sampling points) between two minima, so that the envelope function is able to ignore random "noises".</p>
<b>Envelope (upper)</b>	<p>Upper envelope of <math>G_1</math> with tolerance of <math>C_1</math> points</p> <p>Draws a line that connects the maximum values of a data set. The tolerance defines the minimum distance (in sampling points) between two maxima, so that the envelope function will be able to ignore random "noises".</p>

<b>Exp.</b>	$y = C_1 e^{C_2 G_1}$
	Draws a line of $e$ raised to the power of a data set.
<b>Fourier transform</b>	Discrete Fourier transform of $G_1$ .
	Draws a line of the amplitudes of the harmonics of Fourier transform vs. frequency.
<b>Frequency</b>	The frequency of $G_1$ (minimum of $C_1$ points in one cycle).
	Draws a line of the frequency of a periodic data set vs. time. The constant $C_1$ defines the minimum data points in one cycle.
<b>Integral</b>	$y = C_1 + C_2 \sum G_1 \Delta t$
	Draws a line in which each point is the discrete integral of all the preceding points in a data set.
<b>Linear</b>	$y = C_1 + C_2 G_1$
	Draws a line of a linear displacement of a data set. This function is useful when you want to change the point of origin of a data set.
<b>Ln</b>	$y = C_1 \ln(C_2 G_1)$
	Draws a line of the natural logarithm of a data set. The argument $C_2 G_1$ must be positive.
<b>Log</b>	$y = C_1 \log_{10}(C_2 G_1)$
	Draws a line of the logarithm of a data set to base 10. The argument $C_2 G_1$ must be positive.

**Multiply**

$$y = C_1 G_1 \cdot C_2 G_2$$

Draws a line of the multiplication of two data sets

**Reciprocal  
(1/X)**

$$y = \frac{C_1}{G_1}$$

Draws a line of the reciprocal values of a data set.

**Sine**

$$y = C_1 \sin(C_2 G_1)$$

Draws a line of the sine values of a data set. The argument  $C_2 G_1$  must be expressed in radians.

**Square (X<sup>2</sup>)**

$$y = C_1 (C_2 G_1)^2$$

Draws a line of the squares of a data set.

**Square root**

$$y = C_1 \sqrt{C_2 G_1}$$

Draws a line of the square root values of a data set. : The argument  $C_2 G_1$  must be greater than or equal to zero.

**Subtract**

$$y = C_1 G_1 - C_2 G_2$$

Draws a line the subtraction of two data sets.

**Tan**

$$y = C_1 \tan(C_2 G_1)$$

Draws a line of the tangent values of a data set. The argument  $C_2 G_1$  must be expressed in radians.

## 2.7. Special Tools

### 2.7.1. *Crop Tool*

The Crop tool enables you to trim the edges of a data set. Use it to remove unwanted data.

The time scale of the trimmed data is shifted so that it will start at  $t = 0$ .

If you want the automatic curve fit equation to start at  $t = 0$ , apply the crop tool before any type of curve fitting

After applying the crop tool, the trimmed data set replaces the original set on the graph display and a new icon is added to the Data Map under cropped data.

#### 1. To trim all data up to a point

1. Position a cursor (see page 42) on the data point
2. Click on the **Graph** menu, and then click **Crop**.







#### 2. To trim all data outside a selected range

1. Use the cursors to select the range you want to keep
2. Click on the **Graph** menu, and then click **Crop**.







## 2.8. Toolbar Buttons









### 2.8.1. Main (upper) Toolbar

	<b>New</b>	Start new project
	<b>Open</b>	Open saved project
	<b>Save</b>	Save project
	<b>Print</b>	Select print options
	<b>Run</b>	Start a data recording session. Click on the down-arrow to select recording mode
	<b>Stop</b>	Stop recording
	<b>Download</b>	Download the data from the most recent recording session
	<b>Setup</b>	Open the Setup dialog
	<b>Meter setup</b>	Open the Meter setup dialog
	<b>Data map</b>	Display the Data Map

	<b>Graph</b>	Display the graph window
	<b>Table</b>	Display the table window
	<b>Analysis</b>	Open the Analysis wizard
	<b>Linear fit</b>	Draw a line of linear fit of the selected data set
	<b>Derivative</b>	Draw a line of the derivative of the selected curve
	<b>Display alarm</b>	Displays or removes alarm levels from the graph

### 2.8.2. *Graph Toolbar*

	<b>Zoom in</b>	Zoom in around a selected point or in to a selected range
	<b>Zoom out</b>	Reverse the most recent zoom operation
	<b>Autoscale</b>	Display all the data
	<b>Zoom to selection</b>	Zoom in to a selected area
	<b>Pan</b>	Pan in all directions while in zoom mode
	<b>More smoothing</b>	Smooth (average) the selected curve

	<b>Less smoothing</b>	Reverse the most recent smoothing operation
	<b>1<sup>st</sup> Cursor</b>	Display or remove the first cursor
	<b>2<sup>nd</sup> Cursor</b>	Display or remove the second cursor
	<b>Split graph</b>	Switch to a split graph display
	<b>Edit graph</b>	Select the data to display on the axes
	<b>Graph properties</b>	Graph formatting, scaling and units selection
	<b>Add to project</b>	Add the displayed graph to the project
	<b>Export to Excel</b>	Export the displayed graph to Excel

# Chapter 3 Troubleshooting Guide

## Symptom

## Cause of problem

I pressed the ON key on DaqPRO and it did not turn on.

- Try charging the battery, it may be weak.
- You are using an unsuitable AC/DC adaptor (see page 15).
- The internal 3V disk battery is dead.

DaqLab was unable to connect to DaqPRO.

- DaqPRO is turned off.
- The communication cable is not connected properly.
- The communication cable is not connected to the correct PC COM Port.
- There is no available Serial COM Port.

DaqPRO and DaqLab displays a warning message: "Illegal sensor"

- DaqPRO measured a voltage drop of over 5V across an input that was selected as one of the following types: 50mV, TCK, TCJ, TCT, PT 100 or NTC.
- DaqPRO measured a reversed voltage drop of over -1V across an input that was selected as one of the following types: 50mV, TCK, TCJ, TCT or 10V.

I downloaded "unexpected" data.

- There may be up to 100 files stored in the DaqPRO. Performing a "Download" means loading one of them in sequential order. You have probably loaded an old file accidentally. Try using Selective download from DaqLab (see page 36)

While running with an active trigger, DaqPRO does not complete the data logging.

- The trigger condition has not been fulfilled.
- The trigger condition was fulfilled, but the time period was too short (less than 300 $\mu$ S).



## *Symptom*

I started a new logging and the data logger stopped immediately afterwards.

The recorded data is “noisy”

DaqPRO’s memory is empty – there are no stored files or notes.

## *Cause of problem*

- First check if the sampling rate was so fast that the recording began and ended in less than a second. If this is not the reason, recharge the 7.2V battery and try again. DaqPRO monitors the battery power during the logging. If the battery voltage is less than 5V, the logging is stopped automatically.
- With voltage or current sensors, use short connections between the circuit being tested and the sensor.
- Avoid working near strong electromagnetic fields. (e.g. engines, fluorescent lights)
- The internal 3V disk battery is dead.

# Chapter 4 Specifications

## DaqPRO

### Inputs

- 8 channel differential inputs
- Selectable type for each input: 0-24mA, 0-50mV, 0-10V, NTC, PT-100, Thermocouple, Pulse counter (Input 1 only), frequency (Input 1 only) and user defined sensors

### Input types

#### 0 – 24mA

Range	0 to 24mA
Resolution	0.47 $\mu$ A
Accuracy	$\pm$ 0.5%
Loop impedance	21 $\Omega$
Maximum load	30mA, 5.2V

#### 0 – 50mV

Range	0 to 50mV
Resolution	3 $\mu$ V
Accuracy	$\pm$ 0.5%
Input impedance	50M $\Omega$
Maximum voltage	5.2V

#### 0 – 10V

Range	0 to 10V
Resolution	200 $\mu$ V
Accuracy	$\pm$ 0.5%
Input impedance	125K $\Omega$
Maximum voltage	25V

#### Temperature NTC-1

NTC – 10K $\Omega$ resistor	
Range	-25 to 150 $^{\circ}$ C
Resolution	0.05 $^{\circ}$ C
Accuracy	$\pm$ 0.5%

#### Temperature NTC-2

NTC – 100K $\Omega$ resistor	
Range	-25 to 150 $^{\circ}$ C
Resolution	0.05 $^{\circ}$ C
Accuracy	$\pm$ 0.5%

#### Temperature PT100

Range	-200 $^{\circ}$ C to 400 $^{\circ}$ C	
Resolution	0.1 $^{\circ}$ C (7m $\Omega$ )	
Accuracy	-200 – -50 $^{\circ}$ C	$\pm$ 0.5%
	50 – 400 $^{\circ}$ C	$\pm$ 0.5%
	-50 – 50 $^{\circ}$ C	$\pm$ 0.5%

Possible to connect up to 8 PT100 2 wires or 4 PT100 3 wires

#### Temperature thermocouple J

Range	-200 $^{\circ}$ C to 1,200 $^{\circ}$ C	
Resolution	0.1 $^{\circ}$ C (1 $\mu$ V)	
Accuracy	-200 – -50 $^{\circ}$ C	$\pm$ 0.5%
	50 – 1200 $^{\circ}$ C	$\pm$ 0.5%
	-50 – 50 $^{\circ}$ C	$\pm$ 0.5 $^{\circ}$ C
Cold junction compensation	$\pm$ 0.3 $^{\circ}$ C	

#### Temperature thermocouple K

Range	-250 to 1200 $^{\circ}$ C	
Resolution	0.1 $^{\circ}$ C (1 $\mu$ V)	
Accuracy	-250 – -50 $^{\circ}$ C	$\pm$ 0.5%
	50 – 1200 $^{\circ}$ C	$\pm$ 0.5%
	-50 – 50 $^{\circ}$ C	$\pm$ 0.5 $^{\circ}$ C
Cold junction compensation	$\pm$ 0.3 $^{\circ}$ C	

#### Temperature thermocouple T

Range	-200 to 400 $^{\circ}$ C	
Resolution	0.1 $^{\circ}$ C (1 $\mu$ V)	
Accuracy	-200 – -50 $^{\circ}$ C	$\pm$ 0.5%
	50 – 400 $^{\circ}$ C	$\pm$ 0.5%
	-50 – 50 $^{\circ}$ C	$\pm$ 0.5 $^{\circ}$ C
Cold junction compensation	$\pm$ 0.3 $^{\circ}$ C	

**Pulse counter (input 1 only)**

Zero crossing detector	
Opto coupler interface	
Range	0 to 65,000 counts
Resolution	1 count
Frequency range	0 to 25Hz
Input signal	0 – 5V
Input impedance	470Ω

**Frequency (input 1 only)**

Zero crossing detector	
Opto coupler interface	
Range	20 to 4,000Hz
Time resolution	6.5μs
Input signal	0 – 5V
Input impedance	470Ω

**Internal Temperature**

NTC – 10KΩ resistor	
Range	-25 to 70°C
Resolution	0.1°C (1μV)
Accuracy	±0.3°C

**General A to D specifications**

Noise	30μV rms
Internal linearity error	±0.08% of FSR
Offset error	0.1%

**Alarm output (output 8)**

Open collector	
Input impedance	50Ω
Max. Load	50mA, 5V DC
Overload protection	50mA re-settable fuse

**Communication**

- USB 1.1 compliant

**Sampling**

- Capacity: 512KB
- Analog sampling rate: Variable, 1 sample per hour to 4,000 samples per second, 1 channel
- Analog sampling resolution: 16 bits
- Channel separation 80dB

**Man Machine Interface**

- Full keyboard operation - enables manual programming of the Logger
- Graphic LCD 64x128 pixels

**Power Supply**

- Internal rechargeable 7.2V Ni-MH battery
- Built in battery charger
- External 9V to 12V DC input
- Battery life: 40 hours between charges

**Operating Temperature Range**

- 0 to 50°C

**Casing**

- Plastic ABS box
- Dimensions: 182x100x28 mm
- Weight: 450gr

**Standards Compliance**

- CE, FCC

\* Maximum sampling rate varies with number of used channels (see page 30)

# DaqLab software

## Main features

- Graphical, analysis WINDOWS™ based software for the DaqPRO
- Fast data download from the DaqPRO
- Data displayed in numeric or graphical display forms Graphical display of all inputs
- On-line retrieval and display of data in real-time
- Setup wizard for the DaqPRO
- Define of up to 20 new sensor in the DaqPRO  
Read the defined sensor's units on the logger's display
- Full calibration of the DaqPRO via software
- Documentation and filing
- Alarm levels on graphs
- Export and import to and from spreadsheets
- More than 30 analytical function, for professional analysis of the collected data

## System requirements

### Software

- Windows 98 or later
- Internet Explorer 5.0 or later (you can install Internet Explorer 5 when you install DaqLab, since it ships with the product)

### Hardware

- Pentium 200MHz or higher
- 32 MB RAM (64 MB recommended)
- 10 MB available disk space for the DaqLab application (50 MB to install the supporting applications)

## Ordering Information

Part number	Description
DaqPRO-5300	DaqPRO data logger, user manual, carrying case, AC/DC adapter
SFTDAQ001	DaqLab Windows analysis software, communication cable
DT177	Weather box
AC029	12V Solar cell and battery
DT267	12V AC/DC adapter
DT180	USB communication cable

To order DaqPRO products and accessories:  
<http://www.daqpro.com>

# Appendix: Figures

Figure 1: DaqPRO external connections .....	10
Figure 2: DaqPRO's inputs block terminal .....	12
Figure 3: connecting 3 wire PT 100.....	13
Figure 4: connecting external alarm device.....	14
Figure 5: DaqPRO front panel.....	16
Figure 6: Frequency Aliasing.....	29
Figure 7: DaqLab window layout .....	34
Figure 8: Edit graph dialog .....	45
Figure 9: Setup wizard step 1 of 3.....	52
Figure 10: Setup wizard step 2 of 3.....	53
Figure 11: Setup wizard step 3 of 3.....	54
Figure 12: alarm settings.....	55
Figure 13: X-axis properties dialog.....	57
Figure 14: Triggering dialog.....	58
Figure 15: Edit notes dialog.....	60
Figure 16: Two-point calibration dialog.....	63
Figure 17: Zero calibration dialog .....	66
Figure 18: Define new sensor dialog.....	68
Figure 19: Communication setup dialog .....	70
Figure 20: Analysis wizard – curve fit .....	75
Figure 21: Analysis wizard – averaging .....	76
Figure 22: Analysis wizard – functions.....	77

# Appendix: Simplified measurement circuits

0 to 10V

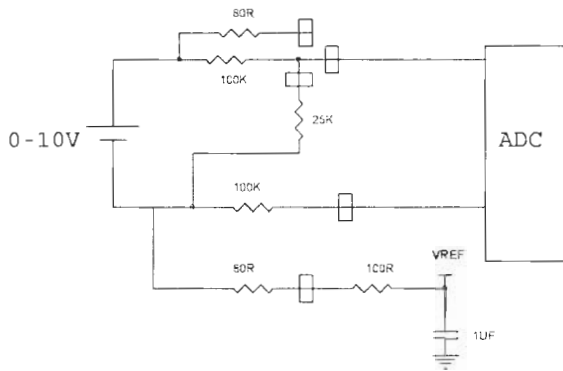

0 to 24mA

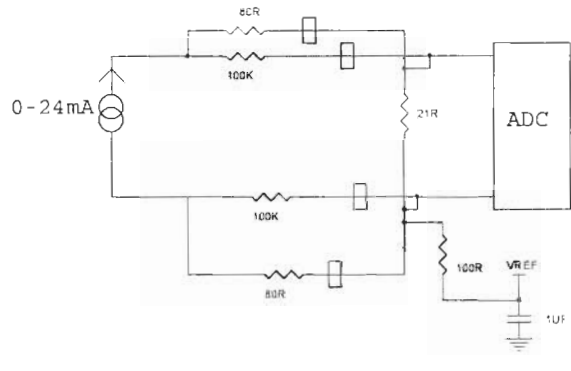

2 wire PT 100

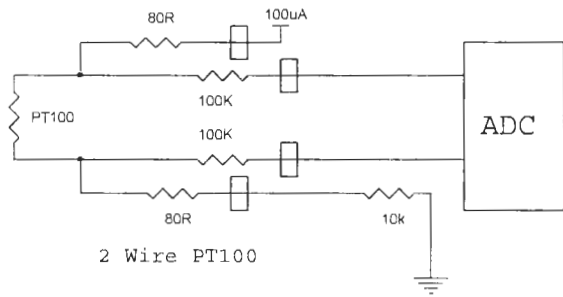

3 wire PT 100

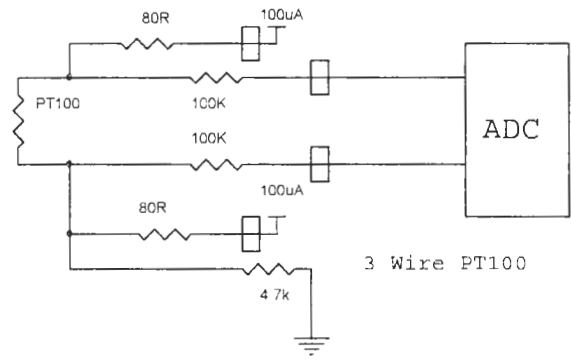

### NTC

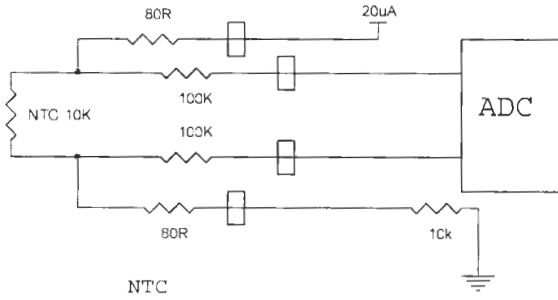

### Internal NTC

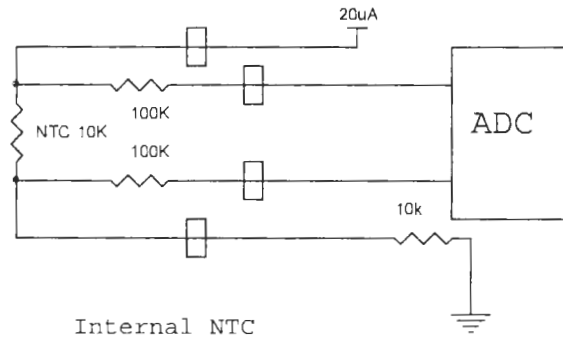

### Thermocouple

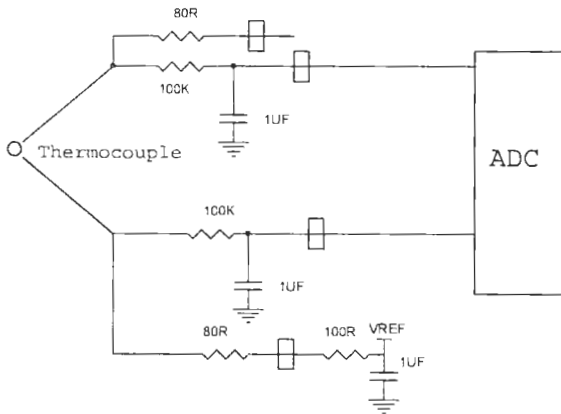



# Index

---

## A

AC/DC adaptor · 15  
alarm · 45  
  level · 13  
  output · 14, 55  
  set · 13  
  setup · 54  
analysis · 72  
  averaging · 76  
  curve fit · 75  
  derivative · 74  
  function · 77  
  integral · 74  
  smoothing · 72  
  wizard · 74  
autoscale · 43  
averaging · 76

---

## B

battery · 15  
  level · 56  
block terminal · 12

---

## C

cable · 9  
calibration · 15, 61  
channels · 11  
chart · See table  
clear  
  data · 50  
  memory · 59

clock  
  internal · 27  
COM port · 70  
comment · 15, 59  
communication · 70  
configuration · 26  
connect · 71  
connection  
  3 wire PT 100 · 12  
  frequency/pulse counter ·  
  12  
  polarity · 12  
  screw terminal · 12  
  to a computer · 11  
continuous · 29, 30  
contrast · 27  
coordinates · 25, 42  
copy · 51  
counter · 12  
crop · 83  
cursor · 25, 42  
curve fit · 73, 75

---

## D

data map · 49  
define  
  custom sensor · 68  
delayed start · See  
  triggering  
delete · 50  
derivative · 74  
display  
  control the display · 49  
  data map · 49  
  graph · 41  
  meters · 48  
  options · 41

properties · 56  
select · 20  
table · 47  
download · 36

---

## E

edit  
  graph · 44  
  notes · 60  
enter · 19, 22  
escape · 22  
event · 14  
event recording · 58  
Excel · 51  
export · 51  
external power · 11

---

## F

filter · 26, 55  
format  
  graph · 46  
  table · 48  
frequency · 12  
functions · 77

---

## G

getting started · 35  
graph · 24, 41

---

## I

icon · 22  
Illegal sensor · 13  
import · 38  
input · 11  
integral · 74

---

## K

keypad · 16

---

## L

layout  
    DadPRO · 16  
    DaqLab · 34  
load  
    last setup · 25  
    notes · 60  
low pass filter · 26, 55

---

## M

mains adaptor · 15  
manual  
    sampling · 29  
memory · 30  
    clear · 27, 59  
menu · 21  
meter · 23, 48

---

## N

noise · 27, 56  
notes · 60  
number

format · 46, 48  
of samples · 19, 22, 54

---

## O

online  
    communication · 36  
open · 37  
output · 14, 55

---

## P

panel · 16  
panning · 44  
Password · 62  
polarity · 12  
power · 11  
preset · 56  
print  
    graph · 39  
    table · 40  
program  
    DaqPRO · 52  
programming  
    rules · 30  
project · 33, 38  
properties  
    graph · 46  
    table · 48  
PT 100  
    3 wire · 12  
PT 100 · 12  
pulse · 12

---

## R

rate · 19, 22, 28, 30, 53, 88  
recharge · 15  
recording

data · 21, 35  
options · 36  
rate · See rate  
start · 59  
stop · 59  
time · 19, 22, 54  
regression · See curve fit  
requirements · 31  
run · 35, 59

---

## S

sampling Points · 29  
sampling rate · See rate  
save · 37  
scale · 43  
screen contrast · 27  
scroll · 53  
sensor · 11, 12, 17  
    assign to input · 52  
    calibration · 61  
    custom · 68  
    plug in · 17  
serial number · 15  
setup · 18, 22, 25, 28, 52  
shut off · 15  
slope · See derivative  
smoothing · 72  
specifications · 89  
spreadsheet · 51  
stand alone · 16  
start · 20, 22, 35  
stop · 21, 22, 35  
system configuration · 26

---

## T

table · 23, 47  
temperature  
    units · 27, 60  
terminal · 12

timer delay · 58  
toolbar  
  graph · 85  
  main · 84  
triggering · 57  
trim · *See* crop  
troubleshooting · 87

---

## U

units  
  format · 46, 48  
  temperature · 27

---

## V

value · 25, 42  
view · 41

---

## W

wizard  
  analysis · 74  
  setup · 52

---

## X

X-axis · 45, 57

---

## Y

Y-axis · 41, 45

---

## Z

zoom · 25, 42